

USER MANUAL

**METER FOR ELECTRICAL
INSTALLATION PARAMETERS**

MPI-502F • MPI-506 • MPI-507

Measuring terminals





USER MANUAL

METER FOR ELECTRICAL INSTALLATION PARAMETERS MPI-502F • MPI-506 • MPI-507



**SONEL S.A.
Wokulskiego 11
58-100 Świdnica
Poland**

Version 2.01 11.03.2022

The MPI-502F / 506 / 507 is a modern, state-of-the art measuring instrument, easy to operate and safe. Read this manual to avoid mistakes during the measurements and prevent operational problems.

CONTENTS

1	Safety	5
1.1	Safety symbols	6
2	Quick start	7
2.1	Switching on and off, display backlight	7
2.2	Selecting general measurement parameters	7
2.3	Remembering the last measurement result	7
3	Measurements	9
3.1	AC voltage measurement	9
3.2	Voltage and frequency measurement	9
3.3	Checking the correctness of PE (protective earth) connections	10
3.4	Fault loop parameters	11
3.4.1	Selecting the lead length	11
3.4.2	Prospective short-circuit current	12
3.4.3	Fault loop parameters in the L-N and L-L circuits	13
3.4.4	Fault loop parameters in the L-PE circuit	16
3.4.5	Fault loop impedance in L-PE circuit protected with a residual current device (RCD)	18
3.5	MPI-507 Resistance-to-earth (R_{E3P})	20
3.6	RCD parameters	25
3.6.1	RCD tripping current	25
3.6.2	RCD tripping time	28
3.6.3	Automatic measurements of RCD parameters	31
3.6.3.1	FULL mode	31
3.6.3.2	STANDARD mode	35
3.7	MPI-506 MPI-507 Insulation resistance	38
3.7.1	Measurement of individual objects	38
3.7.2	Additional information	40
3.8	Low-voltage resistance measurement	41
3.8.1	Test leads resistance compensation – auto-zeroing	41
3.8.2	Low-current resistance measurement	42
3.8.3	Measurement of resistance of protective conductors and equipotential bonding with ± 200 mA current	44
3.9	MPI-506 MPI-507 Phase sequence	46
4	Memory of measurement results	48
4.1	Entering the measurement results to the memory	48
4.2	Changing the cell and bank number	50
4.3	Browsing the memory	50
4.4	Clearing the memory	52
4.4.1	Clearing the bank	52
4.4.2	Clearing the whole memory	53
4.5	Communication with computer	54
4.5.1	Package for cooperation with computer	54
4.5.2	Data transmission with Bluetooth 4.2 module	54
5	Troubleshooting	55
6	Power supply	57
6.1	Monitoring the power supply voltage	57
6.2	Replacing the batteries	57

6.3	General rules of using the Nickel Metal Hydride (Ni-MH) batteries.....	58
7	Cleaning and maintenance	58
8	Storage.....	59
9	Dismantling and disposal	59
10	Technical data	60
10.1	Basic information	60
10.1.1	Voltage measurement.....	60
10.1.2	Frequency measurement	60
10.1.3	Z_{L-PE} , Z_{L-N} , Z_{L-L} fault loop impedance measurement.....	60
10.1.4	Z_{L-PE} fault loop impedance measurement [RCD] (without tripping the RCD).....	61
10.1.5	MPI-507 Measurement of earth resistance – 3-pole method (R_{E3P})	62
10.1.6	Measurement of the RCD parameters.....	62
10.1.7	MPI-506 MPI-507 Measurement of insulation resistance.....	64
10.1.8	Low-voltage continuity and resistance measurement.....	64
10.1.9	MPI-506 MPI-507 Phase sequence.....	65
10.2	Other technical specifications	65
10.3	Additional information	66
10.3.1	Additional uncertainty according to IEC 61557-3 (Z).....	66
10.3.2	Additional uncertainty according to IEC 61557-4 ($R \pm 200$ mA).....	66
10.3.3	Additional uncertainty according to IEC 61557-6 (RCD).....	66
10.3.4	MPI-507 Influence of serial interference voltage on the resistance measurements for function R_{E3P}	66
10.3.5	MPI-507 Influence of the auxiliary electrodes on earth resistance measurements for function R_{E3P}	67
10.3.6	MPI-507 Additional uncertainties according to IEC 61557-5 (R_{E3P})	67
11	Accessories.....	68
11.1	Standard accessories	68
11.2	Optional accessories.....	69
12	Manufacturer	70
13	Laboratory services.....	71

1 Safety

The meter is designed for testing the protection against electric shock in the mains systems. The meter is used to make measurements which results determine the electrical installation safety level. Consequently, in order to ensure safe operation and correct measurement results, observe the following recommendations:

- Before you proceed to operate the meter, acquaint yourself thoroughly with the present manual and observe the safety regulations and recommendations of the manufacturer.
- Any application that differs from those specified in the present manual may cause damage of the instrument and a serious hazard to its user.
- The meters must be operated solely by appropriately qualified personnel with relevant certificates to perform measurements of electric installation. Operation of the instrument by unauthorized personnel may result in damage to the device and constitute a hazard to the user.
- Using this manual does not exclude the need to comply with occupational health and safety regulations and with other relevant fire regulations required during the performance of a particular type of work. Before starting the work with the device in special environments, e.g. potentially fire-risk/explosive environment, it is necessary to consult it with the person responsible for health and safety.
- It is unacceptable to operate the following:
 - ⇒ a damaged meter which is completely or partially out of order,
 - ⇒ leads with damaged insulation,
 - ⇒ a meter which has been stored to long in unsuitable conditions (for example is wet). When the meter is transferred from cold environment to warm and humid one, do not make measurements until the meter warms up to the ambient temperature (about 30 minutes).
- Remember that the **bat** message on the display means that the power supply voltage is too low and indicates the need to replace/ charge the batteries. The measurements performed with the meter with insufficient supply voltage have additional measuring errors which are impossible to be evaluated by the user and cannot be the basis to determine the correct protection of the tested installation.
- Do not leave the discharged batteries in the meter as they can leak and damage the instrument.
- Before starting the measurement, check if the leads are connected to correct measuring terminals.
- Never use the meters with open or only partially closed battery compartment cover and use only the power supplies specified in this manual.
- Repairs may be performed solely by an authorized service outlet.



NOTE!









Only accessories for a given device should be used, as listed in **section 11**. Using other accessories may cause damage to measuring terminals, introduce additional measurement error and create a risk for the user.



- An attempt to install drivers in 64-bit Windows 8 and Windows 10 may result in displaying "Installation failed" message.
 - Cause: Windows 8 and Windows 10 by default blocks drivers without a digital signature.
 - Solution: Disable the driver signature enforcement in Windows.
- Due to continuous development of the meter's software, the actual appearance of the display, in case of some of the functions, may slightly differ from the display presented in this operating manual.

1.1 Safety symbols

The following international symbols are used in the device and/or in this manual:

	Warning; See explanation in the manual		Ground		AC current/voltage
	DC current/voltage		Dual insulation (Protection class)		Declaration of Conformity with EU directives (<i>Conformité Européenne</i>)
	Do not dispose of with other household waste		Recycling information		Confirmed compliance with Australian Standards

Measurement categories according to IEC 61010-2-030:

- **CAT II** – concerns measurements performed in circuits directly connected to low voltage installations,
- **CAT III** – concerns measurements performed in buildings installations,
- **CAT IV** – concerns measurements performed at the source of low voltage installation.

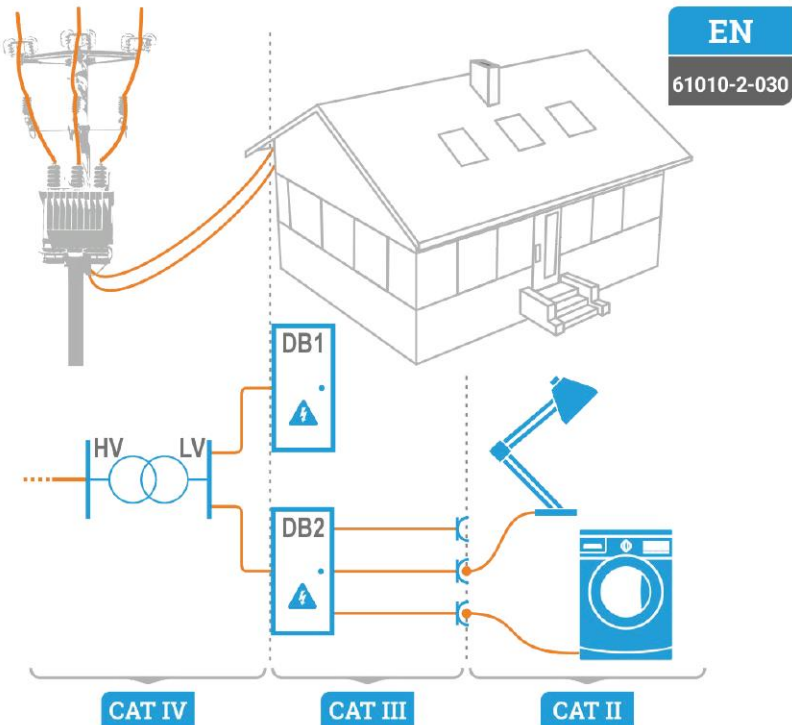



2 Quick start

2.1 Switching on and off, display backlight

To **switch on** the meter, briefly press the  button. To **switch off**, press the same button longer (the **OFF** message appears).

To switch on/off the display and keypad **backlight** during the meter operation, briefly press the  button.

2.2 Selecting general measurement parameters

①  +  Keeping the **SET/SEL** button depressed, switch on the meter and wait for the parameter selection screen to appear.





Use the ◀▶ buttons to go to next parameter.





Use the ▲▼ buttons to change the parameter value. The value or symbol to be changed is flashing.

② Set the parameters according to the algorithm on the right.

③  /  Press and hold **ENTER** (until a signal sounds – ca. 3 s) to save the changes and go to the measurement function or press **ESC** to go the measurement function without saving the changes.



- At first start-up, select the type of power supply: rechargeable batteries (ACCU) or batteries (BATT). General measurement parameters can be selected in the same menu.
- Before the first measurements, set the mains rated voltage U_n (220/380 V, 230/400 V or 240/415 V) which is applicable in the test location. The voltage is used to calculate the prospective short-circuit current, if this option was chosen from the main menu.
- The  symbol means the positive phase or polarization, the  symbol – a negative one.
- The  symbol in the time to auto-off settings, indicates disabling this function.
- The **RCD Auto** mode settings – see **section 3.6.3**.
- PIN settings – see **Meter settings** schematic.
- Software upgrade - see **Meter settings** schematic and **section 4.5**.

2.3 Remembering the last measurement result

The result of the last measurement is remembered until the next measurement is activated, the measurement parameters are changed or the measuring function is changed with the rotary switch. Use the **ESC** button to go to the starting screen of a given function and press **ENTER** to display the last measurement result. Use the same procedure to display the last measurement result after the meter has been switched off (applies to the measurements of Z, RCD, R_{ISO} and R_{CONT}).

Meter settings

Setting	Value	Function	Description
U _n	220 V 230 V 240 V	Mains voltage	Mains voltage
f _n	50 Hz 60 Hz	Mains frequency	Mains frequency
LOOP DISP	k Z	Result of impedance measurement: short-circuit current / impedance	Result of impedance measurement: short-circuit current / impedance
I _k	U U _n	Voltage for calculating I _k : rated / measured	Voltage for calculating I _k : rated / measured
RCD	Auto	RCD-AUTO parameters:	<ul style="list-style-type: none"> enabled / disabled standard mode (STRD) / full mode (FULL)
L-PE RCD	OFF	Auto-OFF	<ul style="list-style-type: none"> disabled time to automatic shutdown
I _A 1/2 I _{ln}	on off	Bluetooth communication: enabled / disabled	Bluetooth communication: enabled / disabled
I _A 1/2 I _{ln}	on off	Change PIN	Change PIN
I _A 5 I _{ln}	ACCU BATT	Power supply selection: rechargeable batteries / batteries	Power supply selection: rechargeable batteries / batteries
I _b	on off	Beeper: enabled / disabled	Beeper: enabled / disabled
I _b	on off	Firmware update	Firmware update
STRD FULL	Auto	Factory reset: yes / no	Factory reset: yes / no

3 Measurements



WARNING

- During the measurements (fault loop impedance, RCD) never touch the earthed and accessible parts in the tested electrical installation.
- During the measurement do not switch the rotary switch as this may cause damage of the meter and hazard for the user.



Message $---$ [no] indicates, that an incompatible measurement adapter is connected to the meter.

3.1 AC voltage measurement

The meter measures and displays the mains alternating voltage in all measurement functions with the exception of **R**. The voltage is measured for the 45...65 Hz frequency range. The test leads should be connected as for a given measuring function.

3.2 Voltage and frequency measurement

①

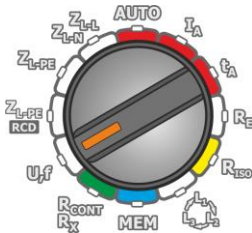

Set the rotary switch to the **U,f** position.

②



Read the measurement result: frequency in the main display field, voltage in the auxiliary field.

3.3 Checking the correctness of PE (protective earth) connections

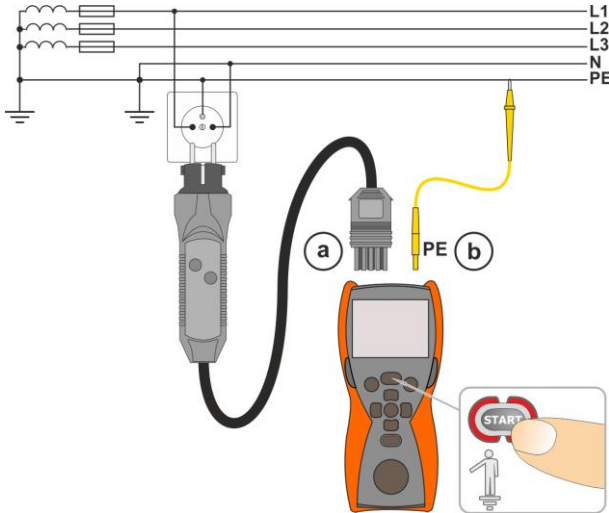

Connect the meters as shown in the figure, touch the contact electrode with your finger and wait about 1 second. When the voltage on the **PE** conductor is detected, the instrument displays the **PE** message (error in the installation, the PE conductor is connected to the phase conductor) and generates a continuous audio signal. This option is available for all measurement functions related to the RCD's and fault loop, except for Z_{L-N,L-L}.



WARNING

When dangerous voltage on the protective conductor PE is detected, discontinue the measurements immediately and repair the electrical installation.



- Make sure that during the measurements you are not standing on an uninsulated floor as this may cause erroneous results.
- The threshold value, which triggers the signal of exceeded allowable voltage on PE conduit, is approximately 50 V.

3.4 Fault loop parameters



NOTE!

- If the tested mains includes residual current devices, for the duration of measurement they should be omitted by bypassing. Remember however that bypassing changes the tested circuit and the results may very slightly differ from the actual values.
- After the measurement, restore the mains to its original state and check operation of the residual current device. This note does not apply to the earth loop impedance measurements with the Z_{L-PE} **RCD** function.
- Measurements of fault loop impedance performed downstream of inverters are ineffective and their results are unreliable. This is due to the instability of internal impedance in inverter circuits during its operation. The measurements of fault loop impedance should not be performed directly downstream of inverters.

3.4.1 Selecting the lead length

1

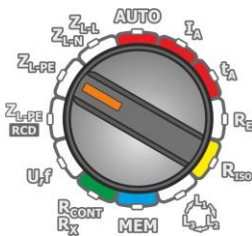

- Switch on the meter.
- Set the rotary switch to one of the fault loop impedance measurement types.

2

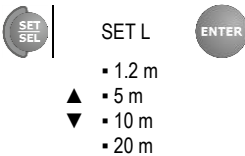

Set the parameters according to the following algorithm and the rules for setting the general parameters.



- Using original leads and selecting correct length is a guarantee of keeping the declared measuring accuracy.
- The **WS-03** and **WS-04** leads are detected by the meter and you cannot select their length (the $\text{--}\bar{E}$ symbol is displayed). When you are using the leads with banana plugs, before you start the measurements set the correct phase conductor length complying with the test leads length.

3.4.2 Prospective short-circuit current

The meter always measures the impedance, and the displayed short-circuit current is calculated according to the following formula:

$$I_k = \frac{U_n}{Z_s}$$

where:

U_n – rated voltage of the tested mains,

Z_s – measured impedance.

Based on the rated voltage U_n selected in the general settings (**section 2.2**), the meter automatically detects the measurement with phase-to-neutral or phase-to-phase voltage and includes this in the calculations.

If the tested mains voltage is out of tolerance range, the meter will not be able to determine the correct rated voltage for calculation of short-circuit current. In such case, horizontal lines will be displayed instead of the short-circuit current. The figure below shows the voltage ranges for which the short-circuit current is calculated.

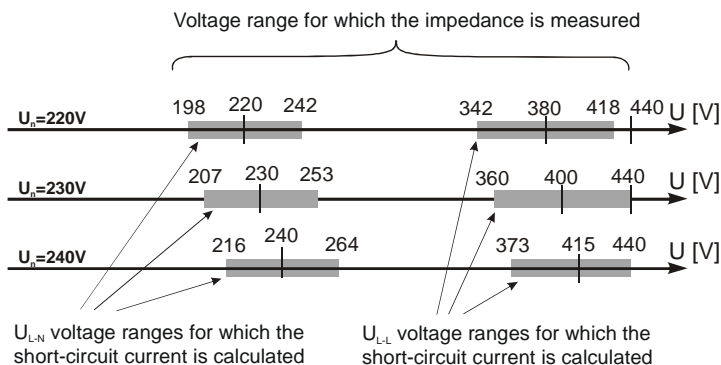

3.4.3 Fault loop parameters in the L-N and L-L circuits

1

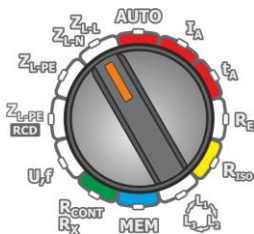

- Switch on the meter.
- Set the rotary switch to the **Z_{L-L} Z_{L-N}** position.
- Select the leads length as described in **sec. 3.4.1** according to the needs.

2 Connect the test leads as shown in the figure:

- (a) (b) for measurement in the L-N circuit,
 (c) measurement in the L-L circuit

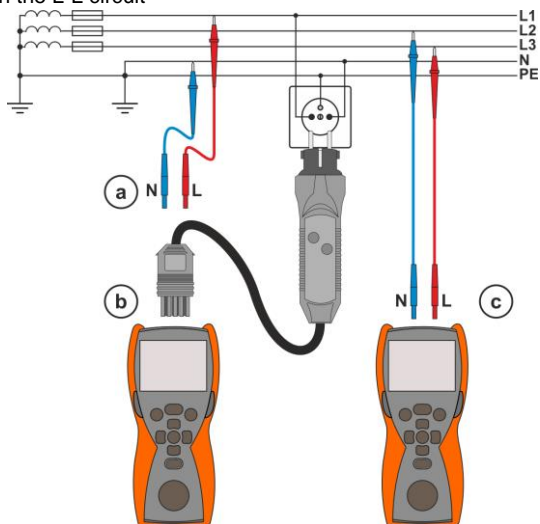

3

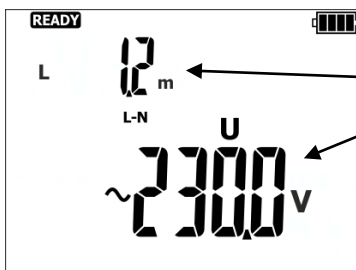

The meter is ready for measurement.

Phase conductor length or the $\sim E$ symbol.

U_{L-N} or U_{L-L} voltage

4



Press **START** to perform the measurement.

5

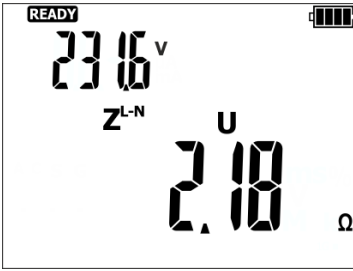

Read the main result: the fault loop impedance Z_S and the mains voltage during the measurement.

6

Press ► to display additional results.

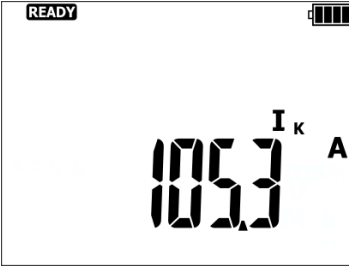

Short-circuit current I_k



Fault loop resistance R

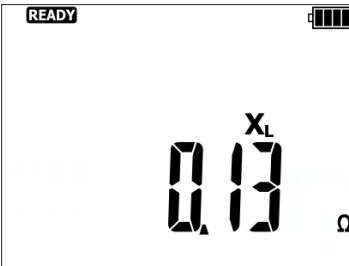



Fault loop reactance X_L



- Save the result in the memory (see **sections 4.1, 4.2**) or press **ESC** to return to the voltage measurement.
- Making a large number of tests over a short time causes the meter to emit a lot of heat. As a result the casing may become warm. This is normal. The meter has an overheat protection.
- The minimum time between successive measurements is 5 seconds. This value is controlled by the meter which displays the **READY** message when you can make the next measurement.

Additional information displayed by the meter

READY	Meter ready for measurement
L-N	Voltage on the meter L and N terminals is out of range for which the measurement can be made.
L-PE	Voltage on the meter L and PE terminals is out of range for which the measurement can be made.
Err	Measurement error
Errf	Incorrect or unstable power grid frequency.
ErrU	Measurement error – loss of voltage after the measurement.
E00	Short-circuit loop of the meter is faulty.
ULn	N conductor not connected.
NOISE!	Message (displayed after the measurement) indicates significant disturbances in the mains during measurement. The measurement result may include a large, unspecified error.
	Temperature inside the meter has exceeded the allowed limit. The measurement is blocked.
	The L and N conductors are switched (voltage between the PE and N conductors).

3.4.4 Fault loop parameters in the L-PE circuit

1

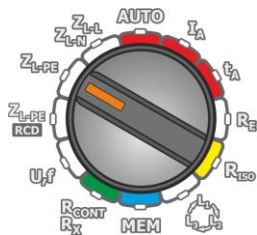

- Switch on the meter.
- Set the rotary switch to the **Z_{L-PE}** position.
- Select the leads length as described in **sec. 3.4.1** according to the needs.

2 Connect the test leads as shown in one of the figures.

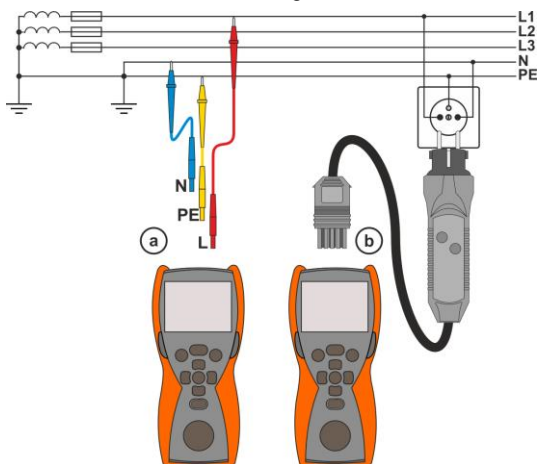

Measurement in L-PE circuit

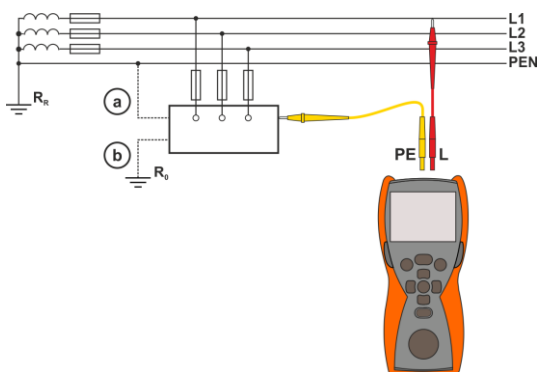

Checking effectiveness of protection against electric shock of the meter housing in case of:

- Ⓐ TN network or Ⓑ TT network

3

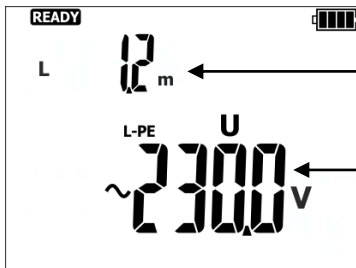

The meter is ready for measurement.

Phase conductor length or the $\sim E$ symbol.

U_{L-PE} voltage

4



Press **START** to perform the measurement.

The remaining measurement issues are analogous to the ones described for the measurements in the L-N or L-L systems.



A double-lead measurement is possible when selecting the test lead other than with the socket adapter.

Additional information displayed by the meter

READY	Meter ready for measurement
L-n	Voltage on the meter L and N terminals is out of range for which the measurement can be made.
L-PE	Voltage on the meter L and PE terminals is out of range for which the measurement can be made.
Err	Measurement error
Errf	Incorrect or unstable power grid frequency.
ErrU	Measurement error – loss of voltage after the measurement.
E00	Short-circuit loop of the meter is faulty.
ULn	N conductor not connected.
NOISE!	Message (displayed after the measurement) indicates significant disturbances in the mains during measurement. The measurement result may include a large, unspecified error.
	Temperature inside the meter has exceeded the allowed limit. The measurement is blocked.
	The L and N conductors are switched (voltage between the PE and N conductors).

3.4.5 Fault loop impedance in L-PE circuit protected with a residual current device (RCD)

The meter allows the fault loop impedance measurements without making changes in the mains with the residual current devices with rated current of minimum 30 mA.

1

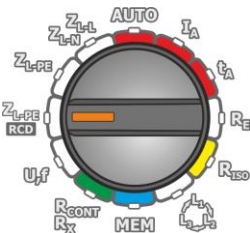

- Switch on the meter.
- Set the rotary switch to the **Z_{L-PE} RCD** position.
- Select the leads length as described in **sec. 3.4.1** according to the needs.

2

Connect the test leads as shown in one of the figures.

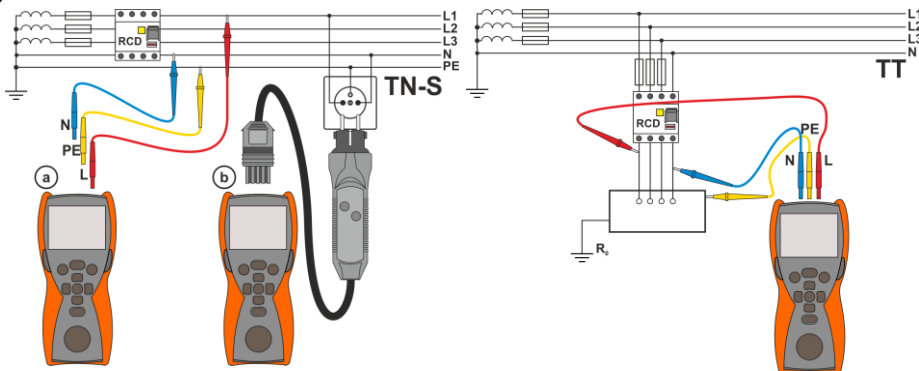

Measurement in a TN-S system

Measurement in a TT system

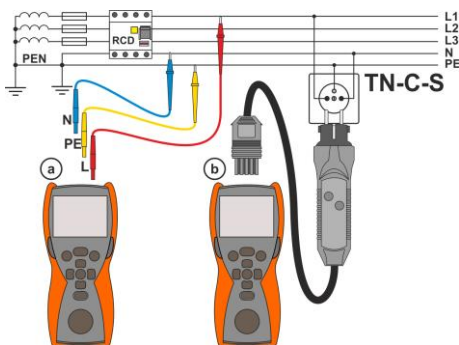

Measurement in a TN-C-S system

The remaining measurement issues are analogous to the ones described for the measurements in the L-N or L-L systems.



- You can discontinue the measurement by pressing the **ESC** button.
- In a mains without interferences, the measurement takes ca. 8 seconds. If interferences occur, this time may be longer.
- In the electrical installations with the 30 mA residual current devices the sum of the installation leakage currents and the test current may trip the RCD. In such case, try to reduce the leakage current of the tested installation (i.e. by disconnecting the loads).

Additional information displayed by the meter

READY	Meter ready for measurement
L-n	Voltage on the meter L and N terminals is out of range for which the measurement can be made.
L-PE	Voltage on the meter L and PE terminals is out of range for which the measurement can be made.
Err	Measurement error
Errf	Incorrect or unstable power grid frequency.
ErrU	Measurement error – loss of voltage after the measurement.
E00	Short-circuit loop of the meter is faulty.
ULn	N conductor not connected.
NOISE!	Message (displayed after the measurement) indicates significant disturbances in the mains during measurement. The measurement result may include a large, unspecified error.
	Temperature inside the meter has exceeded the allowed limit. The measurement is blocked.
	The L and N conductors are switched (voltage between the PE and N conductors).

3.5 **MPI-507** Resistance-to-earth (R_E 3P)

The three-pole measuring method is the basic type of resistance-to-earth measurement.

- 1 Disconnect the tested earth electrode from the installation of the facility.

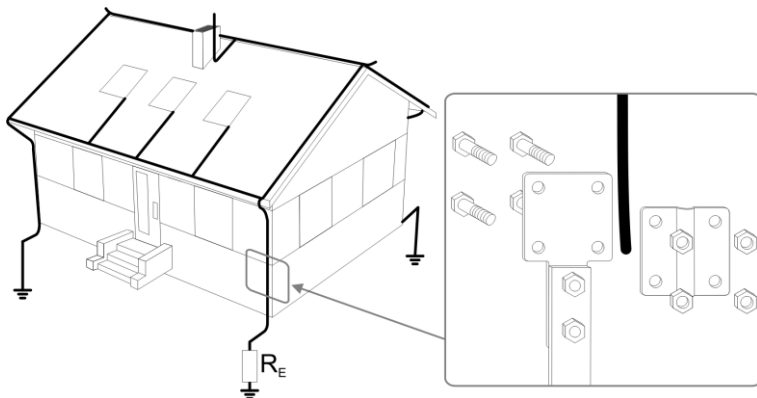

2

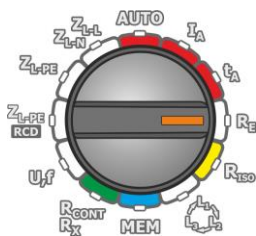

- Switch on the meter.
- Set the rotary switch to the R_E position.

3

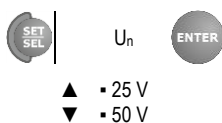

Set the measuring voltage according to the following algorithm and the rules for setting the general parameters.

4 Connect the test leads as shown in one of the figures.

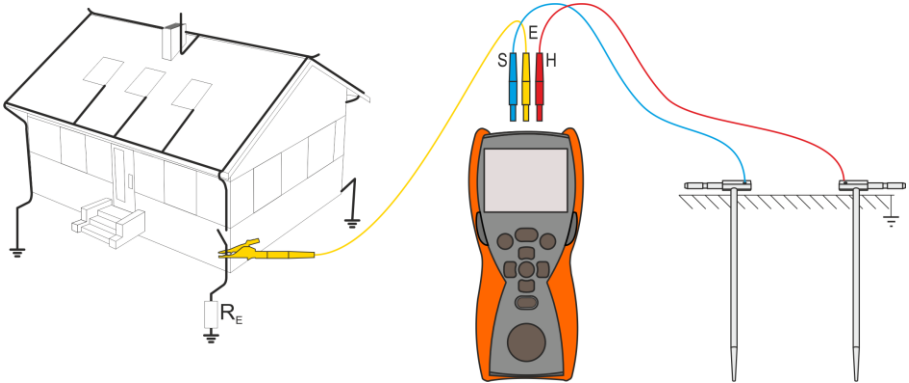

- Drive the **current** electrode **H** into the earth and connect to the **H** socket of the meter.
- Drive the **voltage** electrode **S** into the earth and connect to the **S** socket of the meter.
- The **earth electrode** being tested should be connected to **E** socket of the meter.
- It is recommended that the tested **earth electrode** as well as **H** and **S** electrodes should be located along one line and at relevant distances, in accordance with the rules of earth measurements.

5

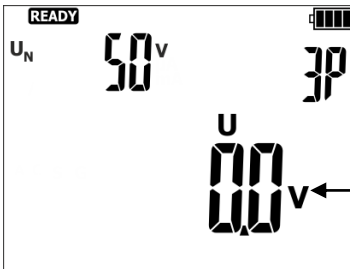

The meter is ready for measurement.

Interference voltage currently on the object

6



Press **START** to perform the measurement.

7

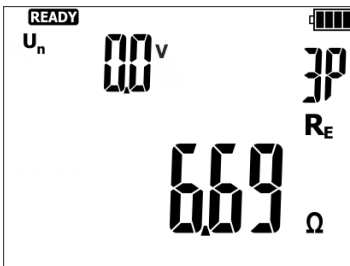

Read the result.

U_n – interference voltage
 R_E – resistance-to-earth

8 Press ► to display additional results.

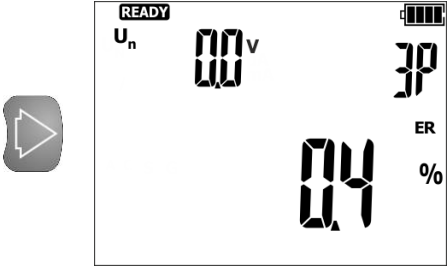

ER – additional uncertainty caused by resistance of the electrodes

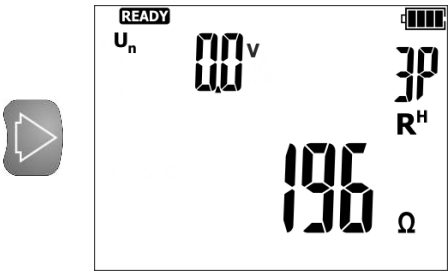

R_H – resistance of current electrode

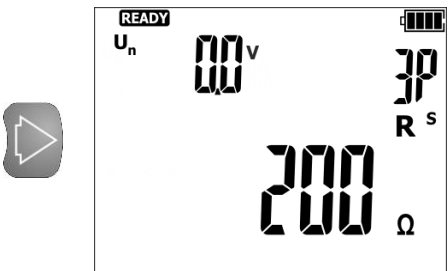

R_S – resistance of voltage electrode

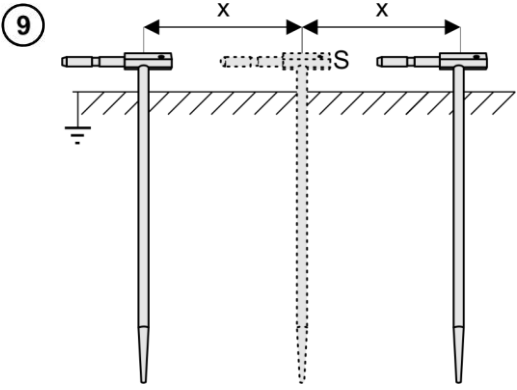

9

Repeat the steps (4) (6) (7) for two additional locations of the voltage electrode S:

- at a certain distance from the tested earth electrode,
- moved closer by the same distance to the tested earth electrode.

This is done to confirm that the S electrode was driven into the reference earth. If so, the difference between the value of R_E between the main measurement and each additional measurement should not exceed 3%.

If R_E measurement results differ from one another by more than 3%, the distance of the current electrode from the earth electrode being tested should be considerably increased and the measurements should be repeated.







WARNING

- **Measurement of resistance-to-earth may be carried out if voltage of interferences does not exceed 24 V. Voltage of interferences is measured up to the level of 100 V.**
- **Over 50 V it is signalled as hazardous. The meter must not be connected to voltages exceeding 100 V.**



- It is recommended that the test **earth electrode** as well as **H** and **S** electrodes should be located in one line. Due to the different field conditions it is not always possible. On the website www.sonel.com and in professional literature special cases of probes location have been discussed.
- Particular attention should be paid to quality of connection between the object being tested and the test lead – the contact area must be free from paint, rust, etc.
- If **resistance of test probes is too high**, R_E earth electrode measurement will **include an additional uncertainty**. Particularly high uncertainty of measurement occurs when the tested resistance is small, and the probes have a weak contact with earth (such a situation occurs frequently when the earth electrode is well made but the upper soil layer is dry and slightly conductive). Then, the ratio of resistance of the probes to resistance of the tested earth electrode is very high and consequently, uncertainty of δ measurement that depends on this ratio is also very high.
- To reduce the uncertainty of the δ , measurement, the contact of the probe with earth may be improved, for example, by:
 - moistening the spot where the probe is driven with water,
 - driving the probe in a different location
 - applying an 80 cm probe.Also, test the test leads for:
 - whether their insulation is not defective
 - whether the lead – banana plug – probe contact areas are not corroded or loosened.In majority of cases the achieved measurement accuracy is satisfactory. However, you should always take account of the uncertainty included in the measurement.

Additional information displayed by the meter

READY	The meter is ready for measurement.
	The tested facility is live. The measurement is blocked. Immediately disconnect the meter from the object (both test leads).
	Interruption in the current probe circuit.
	Interruption in the voltage probe circuit.
	Interruption in measuring circuit or resistance of test probes is higher than 2 kΩ.
RE>1999 Ω	Measuring range is exceeded.
NOISE!	Signal / noise ratio is too low (interfering signal too large).
	Error due to the resistance of electrodes > 30 % (for calculating uncertainty, measured values are taken into account).

3.6 RCD parameters

3.6.1 RCD tripping current

1

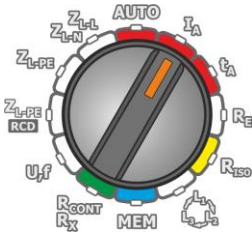

- Switch on the meter.
- Set the rotary switch to the I_A position.

2

Set the parameters according to the following algorithm and the rules for setting the general parameters.

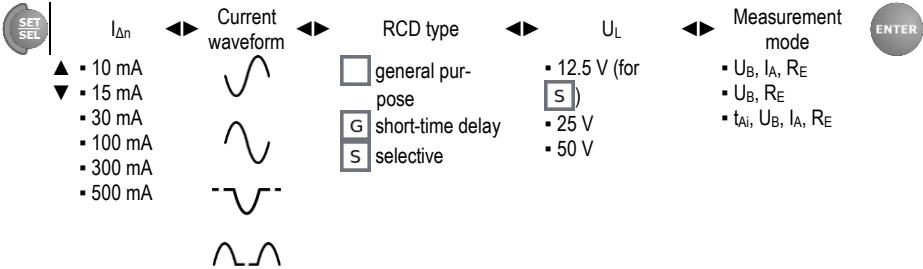

3

Connect the test leads as shown in the figure.

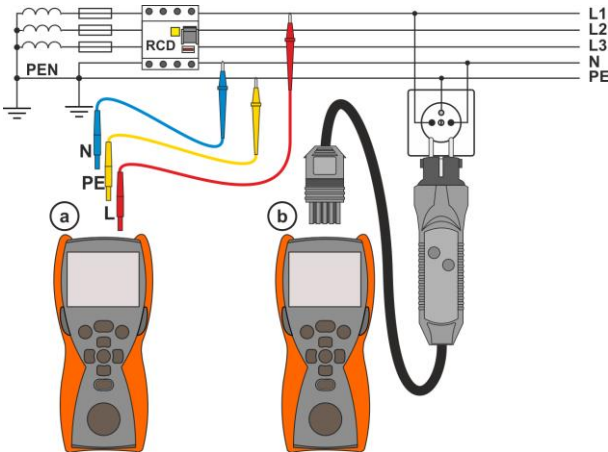

4

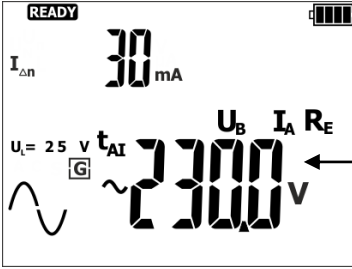

The meter is ready for measurement.

U_{L-PE} voltage

5



Press **START** to perform the measurement.

6

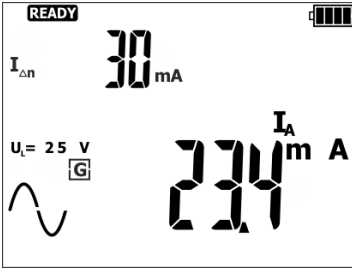

Read the main measurement result: I_A current.

7

Press ► to read additional results.

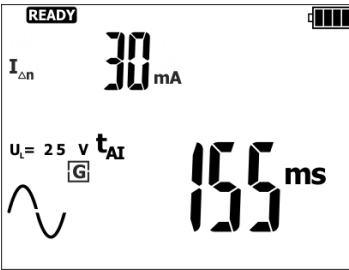

Tripping time t_{AI} at the I_A current

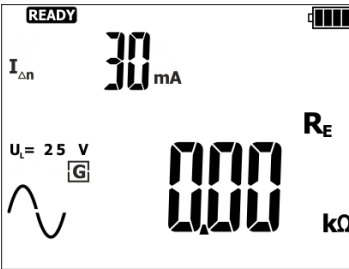

Protective conductor resistance for RCD - R_E

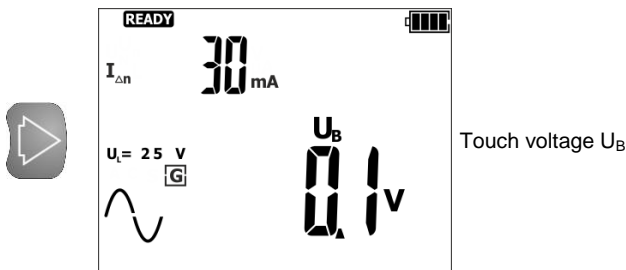

- If only the measurement of U_B , R_E is selected, these values are measured with the $0.4 I_{\Delta n}$ current without tripping the RCD. If the RCD trips during the measurement, press **ESC** to go to the next measurements.
- Due to the specific character of the measurement (step increase of the I_A current), the measurement result for the tripping time t_{Ai} in this mode may include a positive error or the **rCD** message may be displayed due to the RCD inertia. If the result is outside the allowed range for a given RCD, repeat the measurement in the t_A mode (see **section 3.6.2**).
- Save the result in the memory (see **section 4.1**) or press the **ESC** button to display the voltage only. The last measurement result is remembered until you press the **START** button or change the rotary switch position.

Additional information displayed by the meter

READY	Meter ready for measurement
L-PE	Voltage on the meter L and PE terminals is out of range for which the measurement can be made.
↔	The L and N conductors are switched (voltage between the PE and N conductors).
🔧!	Temperature inside the meter has exceeded the allowed limit. The measurement is blocked.
rCD	RCD did not trip or tripped too late.
ErrE	After the U_B R_E measurement, the t_A measurement was not performed because the R_E and voltage values did not allow generating the required current value.
Errf	Incorrect or unstable power grid frequency.
ErrU	Measurement error – loss of voltage after the measurement or RCD tripped during the U_B or R_E measurement.
Ub	Safe touch voltage is exceeded.

3.6.2 RCD tripping time

1

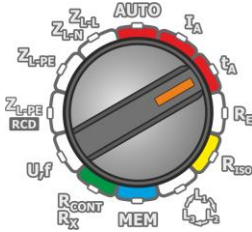

- Switch on the meter.
- Set the rotary switch to the t_A position with the selected $I_{\Delta n}$ multiplication factor.

2

Set the parameters according to the following algorithm and the rules for setting the general parameters.

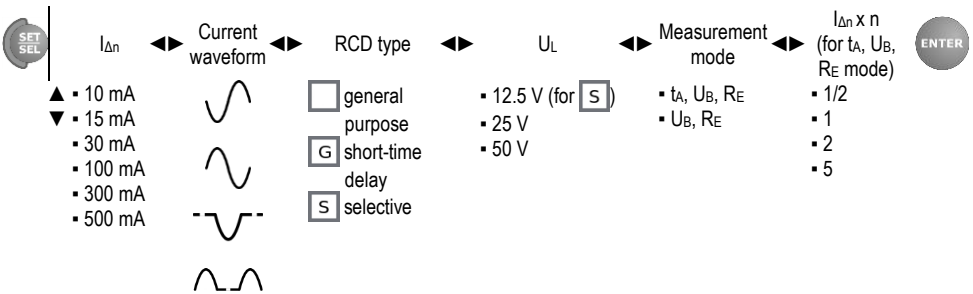

In $I_{\Delta n} \times n$, the multipliers 2 and 5 do not apply to $I_{\Delta n} = 300$ mA and 500 mA.

3

Connect the test leads as shown in the figure.

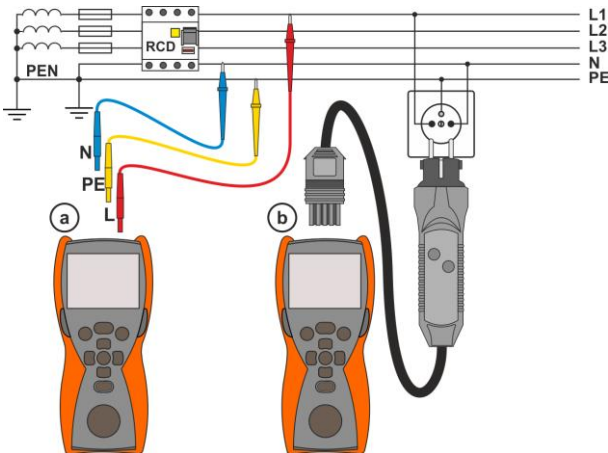

4

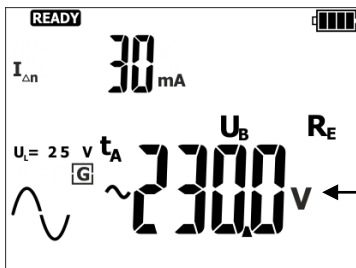

The meter is ready for measurement.

U_{L-PE} voltage

5



Press **START** to perform the measurement.

6

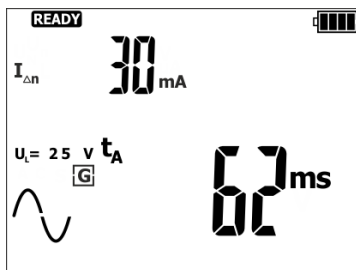

Read the main measurement result: tripping time t_A .

7

Press **▶** to read additional results.

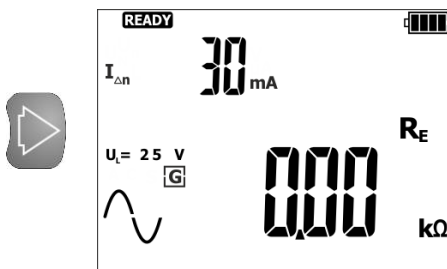

Protective conductor resistance for RCD - R_E

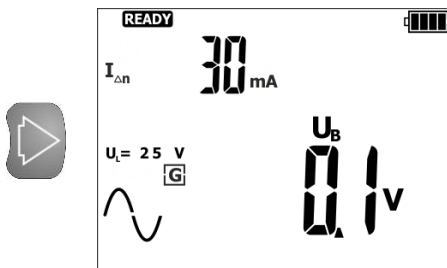



Touch voltage U_B



- If only the measurement of U_B , R_E is selected, these values are measured with the $0.4 I_{\Delta n}$ current without tripping the RCD. If the RCD trips during the measurement, press **ESC** to go to the next measurements.
- Due to the specific character of the measurement (step increase of the I_A current), the measurement result for the tripping time t_{Ai} in this mode may include a positive error or the **rCD** message may be displayed due to the RCD inertia. If the result is outside the allowed range for a given RCD, repeat the measurement in the t_A mode (see **section 3.6.2**).
- Save the result in the memory (see **section 4.1**) or press the **ESC** button to display the voltage only. The last measurement result is remembered until you press the **START** button or change the rotary switch position.

Additional information displayed by the meter

READY	Meter ready for measurement
L-PE	Voltage on the meter L and PE terminals is out of range for which the measurement can be made.
	The L and N conductors are switched (voltage between the PE and N conductors).
	Temperature inside the meter has exceeded the allowed limit. The measurement is blocked.
rCD	RCD did not trip or tripped too late.
ErrE	After the U_B R_E measurement, the t_A measurement was not performed because the R_E and voltage values did not allow generating the required current value.
Errf	Incorrect or unstable power grid frequency.
ErrU	Measurement error – loss of voltage after the measurement or RCD tripped during the U_B or R_E measurement.
Ub	Safe touch voltage is exceeded.

3.6.3 Automatic measurements of RCD parameters

The instrument can perform automatic measurement of the RCD tripping time t_A , tripping current I_A , touch voltage U_B and earth resistance R_E . In this mode, you do not need to activate the measurement each time, and your role is only to initiate the measurement and reset the RCD after each tripping.

You can choose two main AUTO modes:

- FULL mode,
- STANDARD mode.

Mode selection is described in **section 2.2**.

3.6.3.1 FULL mode

1

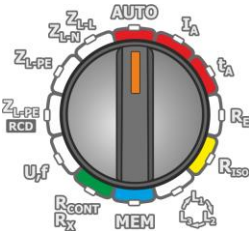

- Switch on the meter.
- Set the rotary switch to the **AUTO** position.

2

If the displayed parameters are different than shown below, set them according to the following algorithm and the rules for setting the general parameters.

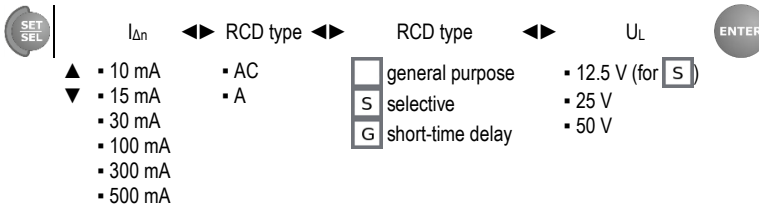

3

Connect the test leads as shown in the figure.

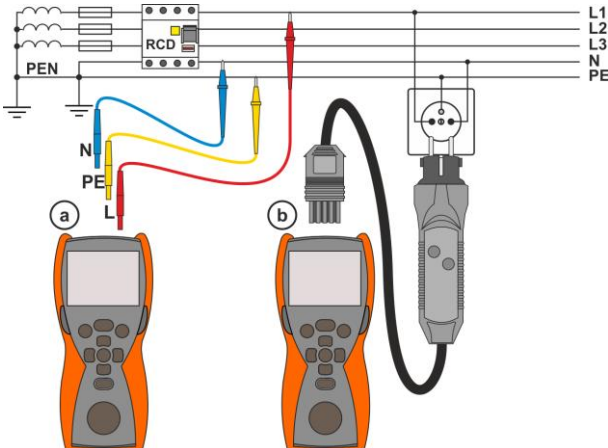

4

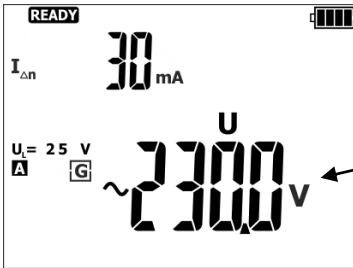

The meter is ready for measurement.

U_{L-PE} voltage

5



Press **START** to perform the measurement.

6

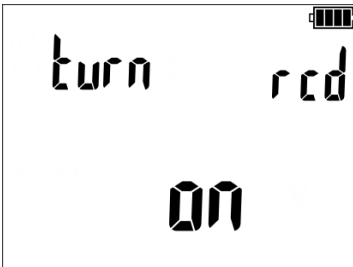

Switch on the tested RCD after each tripping.

7

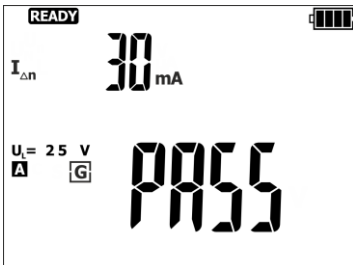

Read the main measurement result:

PASS - good,
FAIL - bad.

Use the **ENTER** button to save the results in the memory, **◀▶** arrows to view the result components, or the **ESC** button to go to the voltage display mode.

The meter can perform the following measurements:

For RCD AC:

Measured parameters	Measurement conditions		Notes
	Multiplication factor $I_{\Delta n}$	Initial phase (polarization)	
Z _{L-PE}		Z _{L-PE}	-
U _{B, R_E}		U _{B, R_E}	
t _A \checkmark	0.5 $I_{\Delta n}$	t _A \checkmark	
t _A \checkmark	0.5 $I_{\Delta n}$	t _A \checkmark	
t _A \checkmark	1 $I_{\Delta n}$	t _A \checkmark	
t _A \checkmark	1 $I_{\Delta n}$	t _A \checkmark	
t _A \checkmark	2 $I_{\Delta n}$	t _A \checkmark	
t _A \checkmark	2 $I_{\Delta n}$	t _A \checkmark	
t _A \checkmark	5 $I_{\Delta n}$	t _A \checkmark	
t _A \checkmark	5 $I_{\Delta n}$	t _A \checkmark	
I _A \checkmark		I _A \checkmark	
I _A \checkmark		I _A \checkmark	

RCD in good working order should trip

For RCD A:

Measured parameters	Measurement conditions		Notes
	Multiplication factor $I_{\Delta n}$	Initial phase (polarization)	
Z _{L-PE}			-
U _{B, R_E}			
t _A \checkmark	0.5 $I_{\Delta n}$	positive	
t _A \checkmark	0.5 $I_{\Delta n}$	negative	
t _A \checkmark	1 $I_{\Delta n}$	positive	
t _A \checkmark	1 $I_{\Delta n}$	negative	
t _A \checkmark	2 $I_{\Delta n}$	positive	
t _A \checkmark	2 $I_{\Delta n}$	negative	
t _A \checkmark	5 $I_{\Delta n}$	positive	
t _A \checkmark	5 $I_{\Delta n}$	negative	
I _A \checkmark		positive	
I _A \checkmark		negative	
t _A \checkmark	0.5 $I_{\Delta n}$	positive	
t _A \checkmark	0.5 $I_{\Delta n}$	negative	
t _A \checkmark	1 $I_{\Delta n}$	positive	
t _A \checkmark	1 $I_{\Delta n}$	negative	
t _A \checkmark	2 $I_{\Delta n}$	positive	
t _A \checkmark	2 $I_{\Delta n}$	negative	
t _A \checkmark	5 $I_{\Delta n}$	positive	
t _A \checkmark	5 $I_{\Delta n}$	negative	
I _A \checkmark		positive	
I _A \checkmark		negative	

RCD in good working order should trip



- Number of measured parameters depends on settings in the main menu.
- U_B and R_E are measured always.
- If during the U_B/R_E measurement, the RCD has tripped at $0.5 I_{\Delta n}$, or has not tripped in the remaining cases, or the preset safe voltage value U_L has been exceeded – the measurement is discontinued.
- The measurements which are not possible are automatically skipped, for example when the selected current $I_{\Delta n}$ and multiplication factor are beyond the meter's measuring capabilities.

Additional information displayed by the meter

	Defective RCD.
	RCD in good working order.
	Switch on the RCD.
	Meter ready for measurement
	Voltage on the meter L and PE terminals is out of range for which the measurement can be made.
	The L and N conductors are switched (voltage between the PE and N conductors).
	Temperature inside the meter has exceeded the allowed limit. The measurement is blocked.
	RCD did not trip or tripped too late.
	After the U_B R_E measurement, the t_A measurement was not performed because the R_E and voltage values did not allow generating the required current value.
	Incorrect or unstable power grid frequency.
	Measurement error – loss of voltage after the measurement or RCD tripped during the U_B or R_E measurement.
	Safe touch voltage is exceeded.

3.6.3.2 STANDARD mode

1

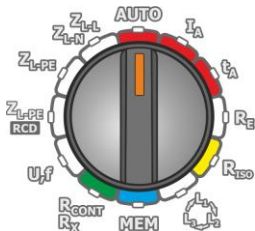

- Switch on the meter.
- Set the rotary switch to the **AUTO** position.

2 If the displayed parameters are different than shown below, set them according to the following algorithm and the rules for setting the general parameters.

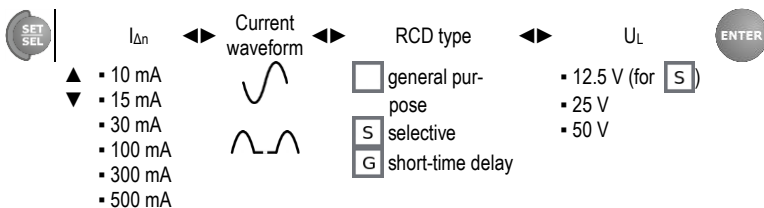

3 Connect the test leads as shown in the figure.

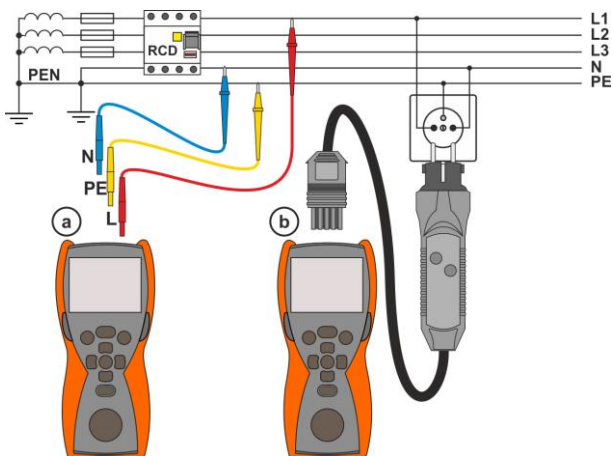

4

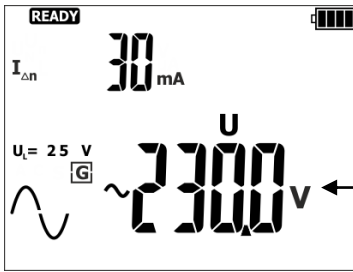

The meter is ready for measurement.

U_{L-PE} voltage

5



Press **START** to perform the measurement.

6

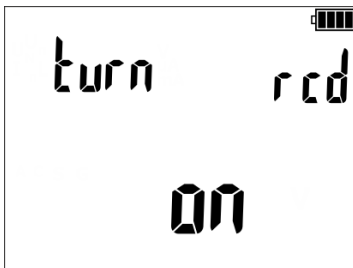

Reset the tested RCD after each tripping.

7





Read the main measurement result:

PASS - good,
FAIL - bad.



- Measured parameters are the same as in the table for the FULL and RCD AC mode only for selected current waveform.
- Number of measured parameters depends on settings in the main menu.
- U_B and R_E are measured always.
- If during the U_B/R_E measurement, the RCD has tripped at 50% I_{Δn}, or has not tripped in the remaining cases, or the preset safe voltage value U_L has been exceeded – the measurement is discontinued.
- The measurements which are not possible are automatically skipped, for example when the selected current I_{Δn} and multiplication factor are beyond the meter's measuring capabilities.

Additional information displayed by the meter

FAIL	Defective RCD.
PASS	RCD in good working order.
turn rcd on	Switch on the RCD.
READY	Meter ready for measurement
L-PE	Voltage on the meter L and N terminals is out of range for which the measurement can be made.
	The L and N conductors are switched (voltage between the PE and N conductors).
	Temperature inside the meter has exceeded the allowed limit. The measurement is blocked.
rcd	RCD did not trip or tripped too late.
ErrE	After the U_B R_E measurement, the t_A measurement was not performed because the R_E and voltage values did not allow generating the required current value.
Errf	Incorrect or unstable power grid frequency.
ErrU	Measurement error – loss of voltage after the measurement or RCD tripped during the U_B or R_E measurement.
Ub	Safe touch voltage is exceeded.

3.7 MPI-506 MPI-507 **Insulation resistance**



WARNING

The object tested must not be live.

3.7.1 Measurement of individual objects

1

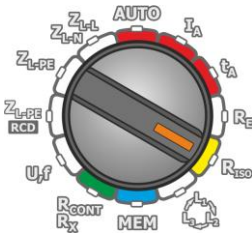

- Turn on the meter.
- Turn the rotary switch to **R_{iso}** position.

2



U_n ◀ Measurement time ▶ ENTER

▲	• 100 V	0'03"
▼	• 250 V	...
	• 500 V	3'00"

Set the measurement voltage according to the following algorithm, and according to the rules described in general parameters setting.

3

Connect test leads according to the drawing. The **R_{iso}+** lead can be connected to the blue or red socket.

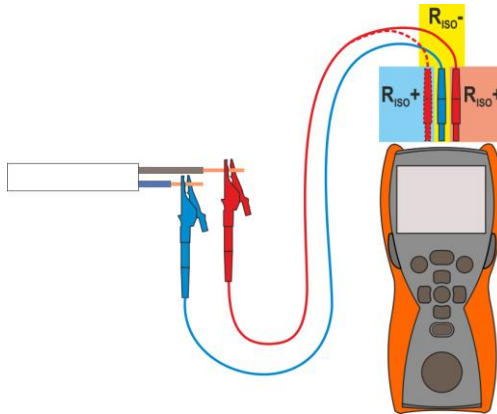

4

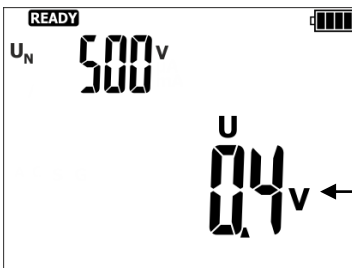

The meter is ready for measurement.

Voltage present on tested object.

5



Press and hold the **START** button for **5 seconds**. Apart from starting the measurement, this will cause 5-second countdown, after which the measurement will be **locked**. Testing will be continued **until it reaches the preset time** or until **START** button is pressed.

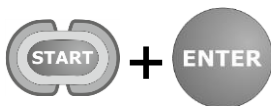

Quick start, without 5-second delay of the measurement lock, perform by pressing **ENTER** and holding the **START** button pressed. The measurement is stopped after reaching the preset time or by pressing **START**.

6

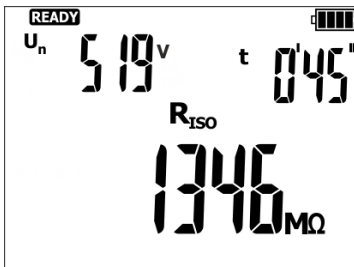

Read out the result.

U_n – measuring voltage

7

Press ► to read additional results.

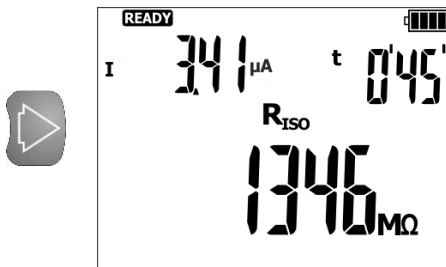

I – measuring current



WARNING







- During measurements of insulation resistance, dangerous voltage up to 600 V occurs at the ends of test leads.
- It is forbidden to disconnect test leads and to change the position of the function switch before completion of measurement. Failure to obey the above instruction will lead to high voltage electric shock and make it impossible to discharge the tested object.



- The meter emits a continuous audio signal until test voltage reaches 90% of the preset value (and also when 110% of the preset value is exceeded).
- During measurement, the meter generates a beep every 5 seconds - it facilitates capturing time parameters.
- When the measurement cycle is upheld by pressing **ENTER** it is indicated by:
 - a short break in the beep, when the test voltage has not reached 90% or exceeded 110% of set value,

- o a short beep if the test voltage is between 90% and 110% of set value.
- Bargraph shows the approximate value of the resistance.
- After completion of measurement, the capacitance of the tested object is discharged by shorting **R_{ISO+}** and **R_{ISO-}** terminals with resistance of 100 kΩ.
- Save the result in the memory (see **section 4.1**) or press the **ESC** button to display the voltage only. The last measurement result is remembered until you press the **START** button or change the rotary switch position.

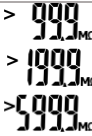
Additional information displayed by the meter

	Test voltage is present on terminals of the meter.
	The tested object is live. The measurement is blocked. Immediately disconnect the meter from the tested object (both leads)!
	Activation of current limit. The symbol displayed is accompanied by a continuous beep.
	The tested object is live. The measurement is possible, but without guaranteed accuracy.
	The insulation resistance is too low, the measurement is terminated. This symbol appears when during the measurement the insulation breakdowns.
	Measuring range is exceeded.
	The tested object is being discharged.

3.7.2 Additional information

The meter measures the insulation resistance by applying to tested resistance R_x tested voltage U_{ISO} and measuring current I flowing through it, which is controlled from **R_{ISO+}** terminal side. In calculating the value of insulation resistance, the meter applies the technical method of resistance measurement ($R_x=U/I$). The test voltage is chosen from values: 100 V, 250 V, 500 V.

Inverter output current is limited at 1 mA level. The measurement result is correct, but on the test terminals the test voltage is lower than voltage selected before the measurement (as illustrated in figure below). Quite often current limitation may occur in the first phase of the measurement due to charging the capacity of the tested object.

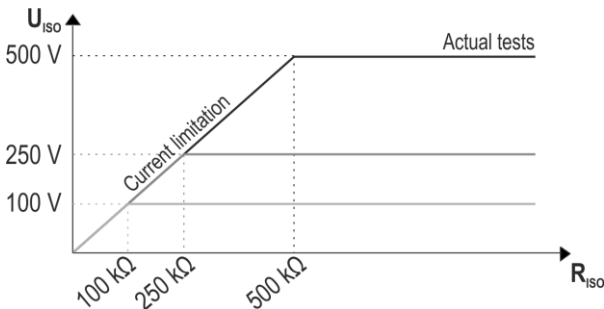

3.8 Low-voltage resistance measurement



NOTE!

Do not connect to the meter voltage above 440 V DC as this can damage the instrument.

3.8.1 Test leads resistance compensation – auto-zeroing

1

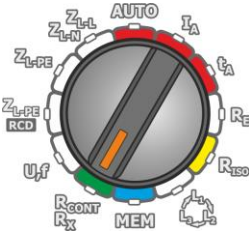

- Switch on the meter.
- Set the rotary switch to the **R_{CONT} R_x** position.

2 Set auto-zeroing according to the following algorithm.



3 Close the test leads.

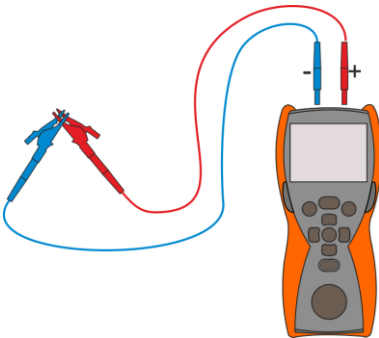

4



Press **START** to commence the auto-zeroing.

5

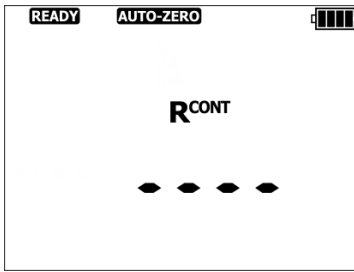

When auto-zeroing is completed, the meter automatically goes to the “ready for measurement” screen.



- The **AUTO-ZERO** message is still displayed after switching to one of the measurement functions (resistance or continuity measurement) in order to indicate that the measurement is being made with compensated test leads resistance.
- To remove compensation, perform the activities described above but with open test leads. The **AUTO-ZERO** message will not be displayed in the measurement screen.

Additional information displayed by the meter

	<p>Tested facility is live. The measurement is blocked. Immediately disconnect the meter from the facility (both leads).</p>
--	---

3.8.2 Low-current resistance measurement

1

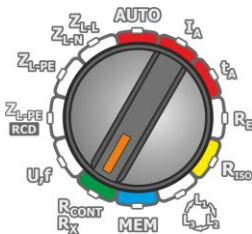

- Switch on the meter.
- Set the rotary switch to the **R_{CONT} R_x** position.

2

If necessary, set the **R_x** measurement according to the following algorithm.

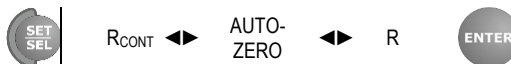

3

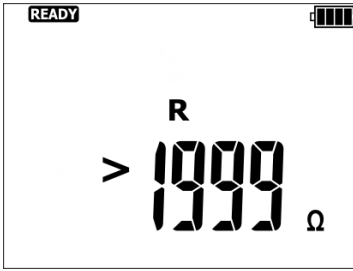

The meter is ready for measurement.

4

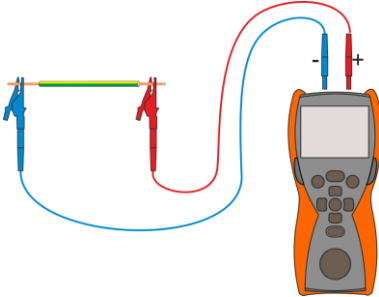

Connect the test leads as shown in the figure.

5

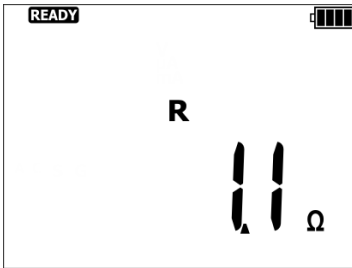

Read the measurement result.

Additional information displayed by the meter

UdEt

Tested facility is live. The measurement is blocked. **Immediately disconnect the meter from the facility (both leads).**

NOISE!

Message (displayed after the measurement) indicates significant disturbances in the mains during measurement. The measurement result may include a large, unspecified error.

> 1999 Ω

Measurement range is exceeded.

3.8.3 Measurement of resistance of protective conductors and equipotential bonding with ± 200 mA current

1

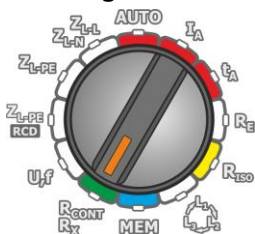

- Switch on the meter.
- Set the rotary switch to the **R_{CONT} R_x**.

2

If necessary, set the **R_{CONT}** measurement according to the following algorithm.

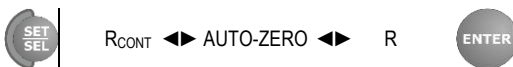

3

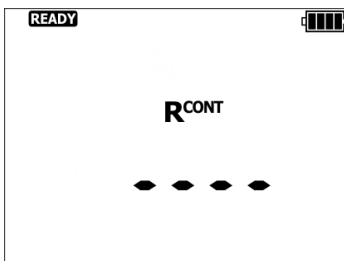

The meter is ready for measurement.

4

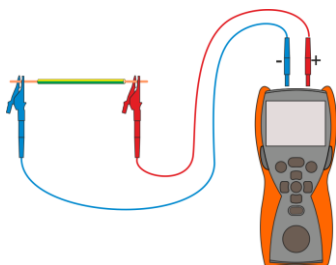

Connect the test leads as shown in the figure. The measurement starts automatically for resistance values below 100 Ω .

5

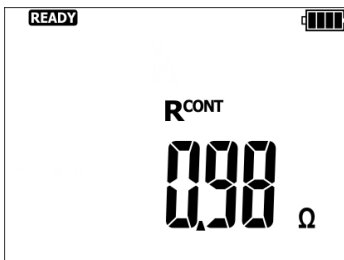

Read the measurement result.

The result is the arithmetic mean of the values of two measurements at a current of 200 mA with opposite polarities **R_{CONT-}** and **R_{CONT+}**.

$$R = \frac{R_{CONT-} + R_{CONT+}}{2}$$

6 Press ► to read additional results.

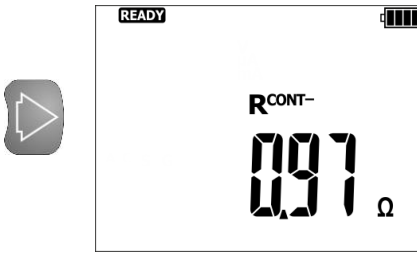

R_{CONT-} – resistance measured with 200 mA negative polarity current

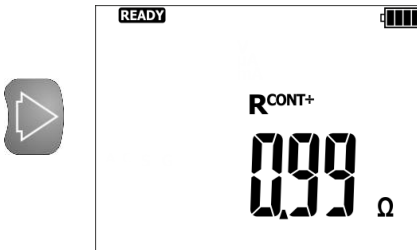

R_{CONT+} – resistance measured with 200 mA positive polarity current

7



Press **START** to start the next measurement without disconnecting the test leads or to measure the resistance above >100 Ω.

Additional information displayed by the meter

UdEt

Tested facility is live. The measurement is blocked. **Immediately disconnect the meter from the facility (both leads).**

NOISE!

Message displayed after the measurement, it indicates significant divergences between the partial measurements (point 6). The measurement result may include a large, unspecified error. Possible causes:

- too much disturbances in the measured object,
- instability of the object or of the meter's connection with the object (unreliable galvanic connection).

> 400 Ω

Measurement range is exceeded.

3.9 MPI-506 MPI-507 Phase sequence

1

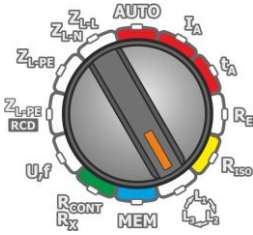

- Turn on the meter.
- Turn the rotary switch to position .

2

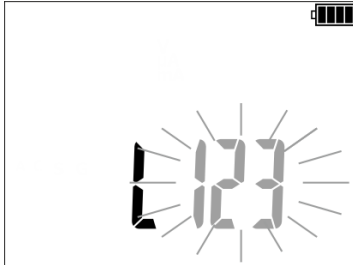

Blinking digits indicate no or low voltage of the phases.

3

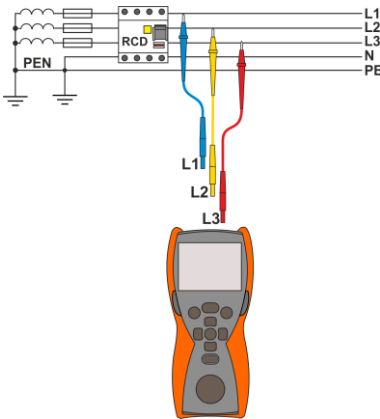

Connect test leads according to the drawing.

4



A set of lines displayed on the bargraph indicates the phase sequence:

- directed to the right - correct,
- directed to the left - opposite.

5

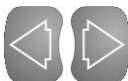

Individual phase-to-phase voltages may be read using ◀▶ buttons.

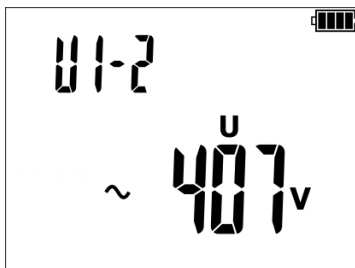

By pressing the ◀▶ buttons you can return to the display of the phase sequence.

4 Memory of measurement results

The meter has the memory for 10 000 individual measurement results. The whole memory is divided into 10 banks with 99 cells each. Due to dynamic memory allocation, each cell can contain a different number of individual results, depending on the needs. This ensures optimum memory use. Each result can be saved in a cell of a specified number and in a chosen bank, thus allowing the user to assign the cell numbers to measurement points, and the bank numbers to tested facilities, make the measurement in any sequence and repeat the measurements without losing other data.

The memory of measurement results is **not cleared** when the meter is switched off. The data can be read later or transmitted to a computer. The number of the current cell and bank is not changed, either.



- One cell can contain the results of measurements made for all measurement functions.
- After each entry of measurement result to a cell, the cell number is automatically increased. To enter the successive results relating to a given measurement point (facility) to one cell, set the correct cell number before each entry.
- Only the results of measurements activated with the **START** button can be entered to the memory (with exception of auto-zeroing in the low-voltage resistance measurement).
- It is recommended to clear the memory after reading the data or before a new series of measurements, results of which can be saved in the same cells as previous ones.

4.1 Entering the measurement results to the memory

1



After the measurement, press **ENTER**.

2

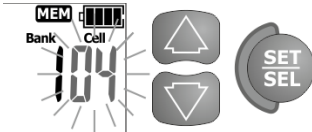

The meter is in the memory enter mode. Select the bank and cell number acc. To **section 4.2** or leave the current ones.



Cell is empty.

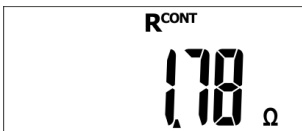

Cell includes the same type of result that is to be entered.



Cell is occupied by the displayed type of measurement results.

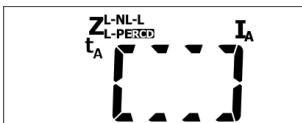

Cell is occupied by the displayed types of measurement results.

3



Confirm by pressing **ENTER**.

4

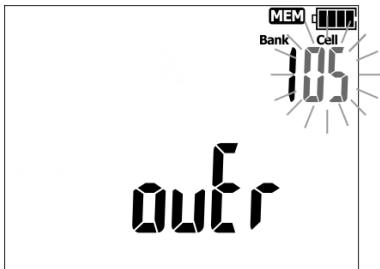

An attempt to overwrite the results triggers the warning message.



Press **ENTER** to overwrite the result or **ESC** to abort.

5

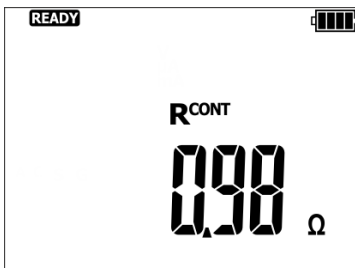

The screen shown left appears for a moment accompanied by three short audio signals. Then, the meter again displays the last measurement result.



- In case of RCD's, this warning will be displayed also when an attempt is made to enter a given result type (component) of the measurement made at a different set $I_{\Delta n}$ current or for a different set RCD type (ordinary/ selective) than the results saved in this cell. Entering the results for a different $I_{\Delta n}$ current or other RCD type will cause deletion of all previously saved results for a given RCD.
- The saved data include a complete set of results (main and additional) for a given measurement function plus the set measurement parameters.

4.2 Changing the cell and bank number

1

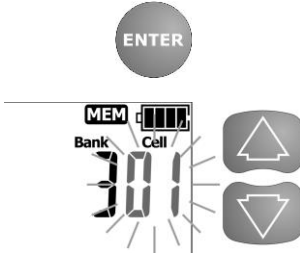

After the measurement, press **ENTER**. The meter is in the memory enter mode.

The cell number is flashing.

Use the ▲▼ arrows to change the cell number.

2

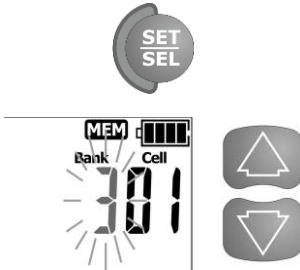

Use the **SET/SEL** button to set the active (flashing) cell or bank number.

The bank number is flashing.

Use the ▲▼ arrows to change the bank number.

4.3 Browsing the memory

1

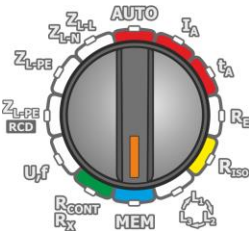

- Switch on the meter.
- Set the rotary switch to the **MEM** position.

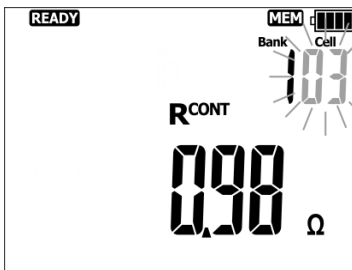

The content of last saved cell is displayed.

The cell number is flashing.

The bank and cell number which you wish to browse is changed with the **SET/SEL** button and then with the ▲▼ arrows. If the cell/ bank number is flashing, it can be changed.

The sequence of saving the individual measurement results is given in the table below:

Measurement function (result group)	Component results
Z _{L-N, L-L}	Z _{L-N} or Z _{L-L}
	and
	U _{L-N} or U _{L-L}
	I _K
Z _{L-PE} or Z _{L-PE} RCD	R
	X _L
	Z _{L-PE} and U _{L-PE}
	I _K
R _E	R
	X _L
	R _E and U _n
	R _H
RCD	R _S
	E _r
	U _B
	R _E
	t _A at 0.5 I _{Δn}
	t _A at 0.5 I _{Δn}
	t _A at 1 I _{Δn}
	t _A at 1 I _{Δn}
	t _A at 2 I _{Δn}
	t _A at 2 I _{Δn}
	t _A at 5 I _{Δn}
	t _A at 5 I _{Δn}
I _A	
I _A	
t _{Ai} (absence for RCD AUTO)	
t _{Aj} (absence for RCD AUTO)	
as above (12 rows) for pulsating current	
and	
R _{ISO}	R _{ISO} and U _N
R _{CONT}	R _{ISO} and I
	R _{CONT}
	R _{CONT-}
	R _{CONT+}

4.4 Clearing the memory

4.4.1 Clearing the bank

1

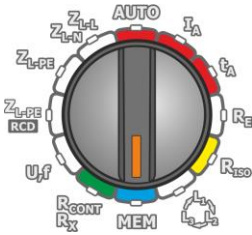

- Switch on the meter.
- Set the rotary switch to the **MEM** position.

2

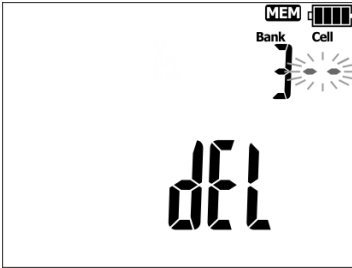

Set the number of bank to be cleared as described in **sec. 4.2**.

Set the cell number to **••** (before 1). The **del** message appears, signaling that the meter is ready to delete.

3

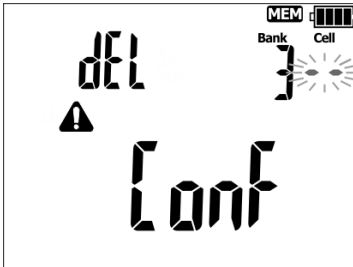

Press **ENTER**. The **Conf** and **!** symbols appear, requiring confirmation.

4

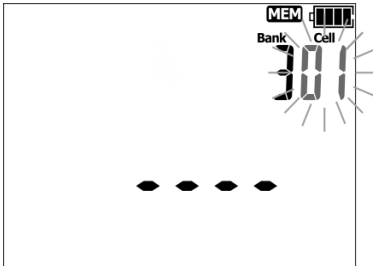

Press **ENTER** to start deleting or **ESC** to abort.

The deletion progress is shown on the screen as scrolling cell numbers. When deletion is completed, the meter generates three short audio signals and sets the cell number to 1.

4.4.2 Clearing the whole memory

1

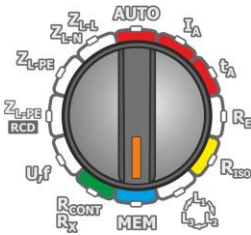

- Switch on the meter.
- Set the rotary switch to the **MEM** position.

2

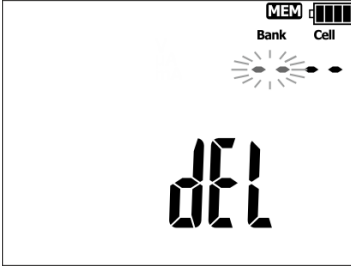

Set the bank number to \leftarrow (before 0). The **del** message appears, signaling that the meter is ready to delete.

3

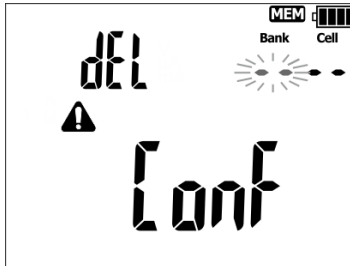

Press **ENTER**. The **Conf** and  symbols appear, requiring confirmation.

4

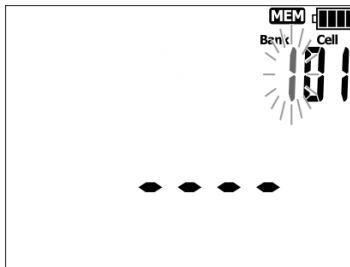

Press **ENTER** to start deleting or **ESC** to abort.

The deletion progress is shown on the screen as scrolling bank and cell numbers. When deletion is completed, the meter generates three short audio signals and sets the cell number to 1.

4.5 Communication with computer













4.5.1 Package for cooperation with computer

In order to ensure the communication of the meter with a computer, additional Bluetooth module and software is required. A program that may be used for this purpose is **Sonel Reader**. It allows users to read and display the measurement data stored in the meter memory. This program may be downloaded free from the manufacturer's website. Information on the availability of other programs cooperating with the meter may be obtained from the manufacturer or its authorized distributors.

The software may be used for many devices manufactured by SONEL S.A. which are equipped with the USB interface and/or wireless module.

Detailed information regarding software is available from the manufacturer or an authorized distributor.

4.5.2 Data transmission with Bluetooth 4.2 module

-  1  +  Keeping the **SET/SEL** button depressed, switch on the meter and wait for the parameter selection screen to appear (see **sec. 2.2**).
-  2   Using buttons ◀▶ go to parameter **bt**.
-  3   Using buttons ▲▼ select **on**.
-  4  Press and hold **ENTER** to save the changes. From now on the symbol  will be visible on the screen.
- 5 Connect Bluetooth module to the USB socket of the PC, unless it is integrated into the PC.
- 6 During the process of pairing the meter with a PC enter PIN code compatible with the PIN code of the meter defined in main settings.
- 7 On the computer start **Sonel Reader**.





Standard pin for Bluetooth is **1234**. Settings in the meter according to **section 2.2**.

5 Troubleshooting

Before sending the instrument for repairs, call our service. Perhaps the meter is not damaged, and the problem has been caused by some other reasons.

The meter can be repaired only at outlets authorized by the manufacturer.

Troubleshooting of typical problems during the use of the meter is described in the table below.

Measurement function	Symptom	Cause	Action
All	The meter will not switch off with the  button.		
	The  symbol appears during voltage measurement.	Discharged or incorrectly placed batteries.	Check if the batteries are placed correctly; replace / charge the batteries. If this has not helped, send the meter for repair.
	The meter switches off during preliminary test.		
	Measurement errors after the meter has been transferred from cold environment to warm and humid one.	No acclimatization.	Do not make measurement until the meter reaches the ambient temperature (about 30 minutes) and dries.
Fault loop and RCD	Successive results in the same measurement point are significantly different.	Incorrect connections in the tested installation.	Check and remove the defects.
		Mains with a lot of disturbance or unstable voltage.	Make more measurements, average the results.
Fault loop	The meter indicates the values close to zero or zero irrespective of the measurement location, and displayed values are significantly different than expected.	Incorrectly chosen test leads in the meter settings.	

Measurement function	Symptom	Cause	Action
RCD	During the touch voltage or earth resistance measurement, the RCD trips (RCD trips at only 40% of the $I_{\Delta n}$ set).	$I_{\Delta n}$ set too high.	Set correct $I_{\Delta n}$.
		Relatively high leakage currents in the installation.	Reduce the leakage currents.
		Defects in the installation.	Verify the correctness of N and PE connections.
	The RCD does not trip during the tripping test.	$I_{\Delta n}$ set too low.	Set correct $I_{\Delta n}$.
		Incorrectly set current waveform.	Set correct current waveform.
		Damaged RCD.	test the RCD with the TEST button; replace if necessary.
		Defects in the installation.	Verify the correctness of N and PE connections.
	During the tripping current measurement, the r_{cd} symbol is displayed even if the RCD has tripped.	The RCD tripping time is longer than the measurement time.	RCD should be considered defective.
	Large differences between repeated measurements of the RCD tripping time.	Pre-magnetization of the transformer core inside the RCD.	Normal for some direct action residual current devices. Try to make next measurements at reversed polarity of the residual current.
	Measurement of t_A or I_A is impossible.	Touch voltage generated during the t_A or I_A measurement may exceed the safe voltage level – the measurement is automatically blocked.	Check connections in the protective conductor.
		$I_{\Delta n}$ set too high.	Set correct $I_{\Delta n}$.
	Unstable U_B or R_E measurement results, i.e. successive results in the same measurement point are significantly different.	Significant leakage currents, highly variable.	
The PE symbol is not displayed even if the voltage between the contact electrode and the PE conductor exceeds the detector tripping threshold (about 50 V).	Contact electrode does not function well or the meter's input circuits are damaged.	Sent the meter for repair. Use of defective meter is not permitted .	
	Rotary switch is not set correctly.	Contact electrode is active for the measurements of earth loop parameters and RCD, with the exception of the $Z_{L-N,L-L}$ $U_{L-N,L-L}$ function.	

6 Power supply

6.1 Monitoring the power supply voltage

The batteries charging level is indicated by the symbol located in the top right-hand corner of the screen:



Batteries charged.



Batteries discharged.

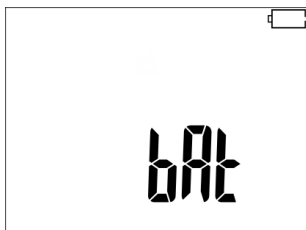

Replace or charge the batteries!

Remember that:

- the **bat** message on the display indicates insufficient power supply voltage and the need to replace or charge the batteries,
- the measurements made with the meter with insufficient power supply voltage have additional measurement error which is impossible to be estimated by the user.

6.2 Replacing the batteries

The power supply of the meter is from four LR6 alkaline batteries or four NiMH rechargeable batteries (size AA). The batteries are in a compartment in the bottom part of the casing.



WARNING

Before replacing the batteries, disconnect the test leads from the meter.

To replace the batteries:

1. Disconnect the leads from the measurement circuit and switch off the meter.
2. Unscrew the bolt fastening the battery compartment cover (in the bottom part of the casing).
3. Replace all batteries. Observe correct polarity when putting new batteries ("+" at the spring part of the contact plate). Reversed polarity of the batteries will not damage the meter or the batteries, but the meter will not work.
4. Put the cover in place and fasten it with the bolt.



NOTE!

- After replacement of batteries, **set the power supply type in the main menu** because correct charging level indication depends on this. Discharging characteristics of batteries and rechargeable batteries are different.
- If batteries leak in the compartment, send the meter to the service outlet.

Rechargeable batteries should be charged in an external charger.

6.3 General rules of using the Nickel Metal Hydride (Ni-MH) batteries

- If you are not going to use the instrument for a longer time, remove the rechargeable batteries and store them separately.
- Store the rechargeable batteries in a dry, cool and well ventilated place and protect them from direct sunlight. The long storage temperature should be below 30°C. If the batteries are stored long at high temperatures, the chemical processes may reduce their life.
- The NiMH rechargeable batteries usually withstand 500-1000 charging cycles. Such batteries achieve full capacity after forming (2-3 discharging and charging cycles). The most important factor which influences the battery life is the discharge level. The deeper the discharge level, the shorter the battery life.
- The memory effect appears in the NiMH batteries in a limited scope. These batteries can be re-charged without more serious consequences. It is, however, recommended to discharge them completely every few cycles.
- During the storage of the Ni-MH rechargeable batteries, they are subject to self-discharge process at the rate of about 30% a month. Keeping the batteries at high temperatures may accelerate this process even two times. In order not to allow an excessive discharging of the batteries (after which the forming will be needed), recharge the batteries once in a while (even unused batteries).
- Modern, fast chargers detect too low and too high temperature of the batteries and respond accordingly. If the temperature is too low, the charging process should not start as it might irrevocably damage a rechargeable battery. The battery temperature increase is a signal to stop the charging and is typical. In addition to faster temperature increase of a battery which will not be fully charged, charging at high ambient temperatures results, however, in a reduced life.
- Remember that with fast charging, the batteries are charged to about 80% of their capacity; better results can be achieved by continuing the charging process: the charger then goes into the small current charging mode and after a few hours the batteries are fully charged.
- Do not charge and do not use the batteries at extreme temperatures as they reduce the life of batteries. Avoid using the battery-powered devices in very hot places. The rated operating temperature must be observed at all times.

7 Cleaning and maintenance



NOTE!

Use only the maintenance methods presented by the manufacturer in this manual.

Clean the meter casing and the case with a wet cloth, using generally available detergents. Do not use any solvents and cleaning media which could scratch the casing (powder, paste, etc.).

The probes can be cleaned with water and then wiped dry. Before longer storage, it is recommended to lubricate the probes with any machine grease.

Clean the spools and leads with water and detergents, then wipe dry.

The meter electronic system is maintenance free.

8 Storage

When storing the instrument, observe the following recommendations:

- disconnect all leads from the meter,
- thoroughly clean the meter and all accessories,
- wind long test leads onto the spools,
- if you are not going to use the instrument for a longer time, remove the batteries,
- during a prolonged storage recharge the batteries from time to time to prevent total discharging.

9 Dismantling and disposal

Used electric and electronic equipment should be collected selectively, i.e. not placed with other types of waste.

Used electronic equipment shall be sent to the collection point according to the Used Electric and Electronic Equipment Act.

Before sending the instrument to the collection point, do not dismantle any parts by yourself.

Observe local regulations on disposal of packagings and used batteries.

10 Technical data

10.1 Basic information

⇒ “m.v.” abbreviation in determination of accuracy means a standard measured value.

10.1.1 Voltage measurement

Range	Resolution	Accuracy
0.0...299.9 V	0.1 V	±(2% m.v. + 6 digits)
300...500 V	1 V	±(2% m.v. + 2 digits)

- Frequency range: 45...65 Hz

10.1.2 Frequency measurement

Range	Resolution	Accuracy
45.0...65.0 Hz	0.1 Hz	±(0,1% m.v. + 1 digit)

- Voltage distribution: 50...500 V

10.1.3 Z_{L-PE} , Z_{L-N} , Z_{L-L} fault loop impedance measurement

Z_S fault loop impedance measurement

Measurement range according to IEC 61557:

Test lead	Measurement range Z_S
1.2 m	0.13...1999 Ω
5 m	0.17...1999 Ω
10 m	0.21...1999 Ω
20 m	0.29...1999 Ω
WS-03 WS-04	0.19...1999 Ω

Display ranges:

Display range	Resolution	Accuracy
0...19.99 Ω	0.01 Ω	±(5% m.v. + 3 digits)
20.0...199.9 Ω	0.1 Ω	±(5% m.v. + 3 digits)
200...1999 Ω	1 Ω	±(5% m.v. + 3 digits)

- Rated operating voltage U_{nL-N} / U_{nL-L} : 220/380 V, 230/400 V, 240/415 V
- Voltage operating range: 180...270 V (for Z_{L-PE} and Z_{L-N}) and 180...460 V (for Z_{L-L})
- Mains rated frequency f_n : 50 Hz, 60 Hz
- Frequency operating range: 45...65 Hz
- Maximum test current: 7.6 A for 230 V (4x10 ms), 13.3 A for 400 V (4x10 ms)
- Check of PE terminal connection correctness with the contact electrode (for Z_{L-PE})

Readings of fault loop impedance R_S and fault loop reactance X_S

Display range	Resolution	Accuracy
0...19.99 Ω	0.01 Ω	±(5% + 5 digits) of Z_S value
20.0...199.9 Ω	0.1 Ω	±(5% + 5 digits) of Z_S value

- Calculated and displayed values $Z_S < 200 \Omega$

Readings of short-circuit current I_k

Measurement ranges according to IEC 61557 can be calculated from the measurement ranges Z_S and rated voltages.

Display range	Resolution	Accuracy
0.110...1.999 A	0.001 A	Calculated on the basis of accuracy for the fault loop
2.00...19.99 A	0.01 A	
20.0...199.9 A	0.1 A	
200...9999 A	1 A	

- Prospective fault current calculated and displayed by the meter may slightly differ from the value calculated by the user with a calculator, basing on the displayed value of the impedance, because the meter calculates the current from unrounded value of fault loop impedance (which is used for displaying). As the correct value, consider I_k current value, displayed by the meter or by firmware.

10.1.4 Z_{L-PE} fault loop impedance measurement **RCD** (without tripping the RCD)

Z_S fault loop impedance measurement

Measurement range according to IEC 61557: 0.5...1999 Ω for the 1.2 m leads, WS-03 and WS-04, and 0.51...1999 Ω for the 5 m, 10 m and 20 m leads

Display range	Resolution	Accuracy
0...19.99 Ω	0.01 Ω	$\pm(6\% \text{ m.v.} + 10 \text{ digits})$
20.0...199.9 Ω	0.1 Ω	$\pm(6\% \text{ m.v.} + 5 \text{ digits})$
200...1999 Ω	1 Ω	$\pm(6\% \text{ m.v.} + 5 \text{ digits})$

- Does not trip the RCD's with $I_{\Delta n} \geq 30 \text{ mA}$
- Rated operating voltage U_n : 220 V, 230 V, 240 V
- Voltage operating range: 180...270 V
- Mains rated frequency f_n : 50 Hz, 60 Hz
- Frequency operating range: 45...65 Hz
- Check of PE terminal connection correctness with the contact electrode

Readings of fault loop impedance R_S and fault loop reactance X_S

Display range	Resolution	Accuracy
0...19.99 Ω	0.01 Ω	$\pm(6\% + 10 \text{ digits})$ of Z_S value
20.0...199.9 Ω	0.1 Ω	$\pm(6\% + 5 \text{ digits})$ of Z_S value

- Calculated and displayed values $Z_S < 200 \Omega$

Readings of short-circuit current I_k

Measurement ranges according to IEC 61557 can be calculated from the measurement ranges Z_S and rated voltages.

Display range	Resolution	Accuracy
0.110...1.999 A	0.001 A	Calculated on the basis of accuracy for the fault loop
2.00...19.99 A	0.01 A	
20.0...199.9 A	0.1 A	
200...9999 A	1 A	

- Prospective fault current calculated and displayed by the meter may slightly differ from the value calculated by the user with a calculator, basing on the displayed value of the impedance, because the meter calculates the current from unrounded value of fault loop impedance (which is used for displaying). As the correct value, consider I_k current value, displayed by the meter or by firmware.

10.1.5 MPI-507 Measurement of earth resistance – 3-pole method (R_E3P)

The measurement method: 3-pole, in accordance with EN 61557-5

Range of measurement in accordance with IEC 61557-5: $0.63 \Omega \dots 1999 \Omega$ for $U_n = 50 V$.

Display range	Resolution	Accuracy
0.00...19.99 Ω	0.01 Ω	$\pm(3\% \text{ m.v.} + 5 \text{ digits})$
20.0...199.9 Ω	0.1 Ω	
200...1999 Ω	1 Ω	$\pm 5\% \text{ m.v.}$

- Measuring current at the short circuit: 15 mA.
- Measuring frequency: 125 Hz or 150 Hz.
- Selected test voltage: 25 V or 50 V.
- Maximum interference voltage for the R_E measurement: 24 V.

10.1.6 Measurement of the RCD parameters

- Rated operating voltage U_n : 220 V, 230 V, 240 V
- Voltage operating range: 180...270 V
- Mains rated frequency f_n : 50 Hz, 60 Hz
- Frequency operating range: 45...65 Hz

RCD tripping test and t_A tripping time measurement (for t_A measurement function)

Measurement range according to IEC 61557: 10 ms ... to the upper limit of displayed value









RCD type	Multiplication factor setting	Measurement range	Resolution	Accuracy
general	0.5 $I_{\Delta n}$	0...300 ms	1 ms	$\pm(2\% \text{ m.v.} + 2 \text{ digits})^{1)}$
	1 $I_{\Delta n}$			
	2 $I_{\Delta n}$	0...150 ms		
	5 $I_{\Delta n}$	0...40 ms		
selective	0.5 $I_{\Delta n}$	0...500 ms		
	1 $I_{\Delta n}$			
	2 $I_{\Delta n}$	0...200 ms		
	5 $I_{\Delta n}$	0...150 ms		

1) for $I_{\Delta n} = 10 \text{ mA}$ and 0.5 $I_{\Delta n}$ the accuracy is $\pm(2\% \text{ m.v.} + 3 \text{ digits})$

• Residual current feed accuracy:

for 1 $I_{\Delta n}$, 2 $I_{\Delta n}$ and 5 $I_{\Delta n}$ 0...8%
 for 0.5 $I_{\Delta n}$ -8...0%

RMS leakage current during the RCD tripping time measurement

$I_{\Delta n}$	Multiplication factor setting							
	0.5		1		2		5	
								
10	5	3.5	10	20	20	40	50	100
30	15	10.5	30	42	60	84	150	210
100	50	35	100	140	200	280	500	—
300	150	105	300	420	—	—	—	—
500	250	175	500	—	—	—	—	—

Re - protective conductor resistance for RCD

Selected RCD rated current	Measurement range	Resolution	Test current	Accuracy
10 mA	0.01 kΩ...5.00 kΩ	0.01 kΩ	4 mA	0....+10% m.v. ±8 digits
30 mA	0.01 kΩ...1.66 kΩ		12 mA	0....+10% m.v. ±5 digits
100 mA	1 Ω...500 Ω	1 Ω	40 mA	0....+5% m.v. ±5 digits
300 mA	1 Ω...166 Ω		120 mA	
500 mA	1 Ω...100 Ω		200 mA	

Measurement of touch voltage U_B referred to rated residual current

Measurement range according to IEC 61557: 10...50 V

Measurement range	Resolution	Test current	Accuracy
0...9,9 V	0.1 V	0.4 x $I_{\Delta n}$	0...10% m.v. ± 5 digits
10.0...99.9 V			0...15% m.v.

RCD I_A tripping current measurement for sinusoidal residual current

Measurement range according to IEC 61557: $(0.3...1.0)I_{\Delta n}$

Selected RCD rated current	Measurement range	Resolution	Test current	Accuracy
10 mA	3.0...10.0 mA	0,1 mA	$0,3 \times I_{\Delta n}...1,0 \times I_{\Delta n}$	$\pm 5\% I_{\Delta n}$
15 mA	4,5...15,0 mA			
30 mA	9,0...30,0 mA			
100 mA	30...100 mA	1 mA		
300 mA	90...300 mA			
500 mA	150...500 mA			

- It is possible to start the measurement from positive or negative half-period of forced residual current
- Test current flow time max. 3200 ms

RCD I_A tripping current measurement for unidirectional pulsating residual current

Measurement range according to IEC 61557: $(0.4...1.4)I_{\Delta n}$ for $I_{\Delta n} \geq 30$ mA and $(0.4...2)I_{\Delta n}$ for $I_{\Delta n} = 10$ mA

Selected RCD rated current	Measurement range	Resolution	Test current	Accuracy
10 mA	3.5...20.0 mA	0.1 mA	0.35 $I_{\Delta n}...2.0 I_{\Delta n}$	$\pm 10\% I_{\Delta n}$
15 mA	5.3...21.0 mA		0.35 $I_{\Delta n}...1.4 I_{\Delta n}$	
30 mA	10.5...42.0 mA		1 mA	
100 mA	35...140 mA			
300 mA	105...420 mA			

- It is possible to start the measurement from positive or negative half-period of forced residual current
- Test current flow time max. 3200 ms

10.1.7 MPI-506 MPI-507 Measurement of insulation resistance

Test range according to IEC 61557-2 for $U_N = 100 \text{ V}$: 100 k Ω ...99.9 M Ω

Display range for $U_N = 100 \text{ V}$	Resolution	Accuracy
0...1999 k Ω	1 k Ω	$\pm(5\% \text{ m.v.} + 8 \text{ digits})$
2.00...19.99 M Ω	0.01 M Ω	
20.0...99.9 M Ω	0.1 M Ω	

Test range according to IEC 61557-2 for $U_N = 250 \text{ V}$: 250 k Ω ...199.9 M Ω

Display range for $U_N = 250 \text{ V}$	Resolution	Accuracy
0...1999 k Ω	1 k Ω	$\pm(5\% \text{ m.v.} + 8 \text{ digits})$
2.00...19.99 M Ω	0.01 M Ω	
20.0...199.9 M Ω	0.1 M Ω	

Test range according to IEC 61557-2 for $U_N = 500 \text{ V}$: 500 k Ω ...599.9 M Ω

Display range for $U_N = 500 \text{ V}$	Resolution	Accuracy
0...1999 k Ω	1 k Ω	$\pm(5\% \text{ m.v.} + 8 \text{ digits})$
2.00...19.99 M Ω	0.01 M Ω	
20.0...599.9 M Ω	0.1 M Ω	

- Test voltage: 100 V, 250 V, 500 V
- Accuracy of generated voltage (Robc [Ω] $\geq 1000 \cdot U_N$ [V]): -0+10% from the set value
- Detection of a dangerous voltage before commencing a measurement
- Discharging the object tested
- Measurement of voltage on terminals +R_{ISO}, -R_{ISO} within the range of 0...440 V
- Test current <2 mA

10.1.8 Low-voltage continuity and resistance measurement

Continuity measurements of protective conductors and equipotential bonding with the $\pm 200 \text{ mA}$ current

Measurement range according to IEC 61557-4: 0.12...400 Ω

Range	Resolution	Accuracy
0.00...19.99 Ω	0.01 Ω	$\pm(2\% \text{ m.v.} + 3 \text{ digits})$
20.0...199.9 Ω	0.1 Ω	
200...400 Ω	1 Ω	

- Voltage on open terminals: 4...20 V
- Output current at $R < 2 \Omega$: min 200 mA (I_{SC} : 200...250 mA)
- Test leads resistance compensation
- Measurements for both current polarities

Low-current resistance measurement

Range	Resolution	Accuracy
0.0...199.9 Ω	0.1 Ω	$\pm(3\% \text{ m.v.} + 3 \text{ digits})$
200...1999 Ω	1 Ω	

- Voltage on open terminals: 4...20 V
- Short-circuit current I_{SC} : 8...15 mA
- Audio signal for measured resistance $< 30 \Omega \pm 50\%$
- Test leads resistance compensation

10.1.9 **MPI-506 MPI-507** Phase sequence

- Phase sequence indication: correct, incorrect
- Range of mains voltage U_{L-L} : 100...440 V (45...65 Hz)
- Display of phase-to-phase voltages

10.2 Other technical specifications

- a) Insulation type according to EN 61010-1 and IEC 61557double
- b) Measurement category according to EN 61010-1 IV 300 V (III 600 V)
- c) casing protection rating according to EN 60529 IP67
- d) meter power supplyLR6 alkaline batteries or AA size NiMH rechargeable batteries (4 pcs)
- e) dimensions 220 x 98 x 58 mm
- f) weight ca. 0.8 kg
- g) storage temperature -20...+70°C
- h) operating temperature 0...+50°C
- i) humidity 20...90%
- j) reference temperature +23 ± 2°C
- k) reference humidity 40...60%
- l) altitude (above sea level) ≤2000 m*
- m) time to Auto-OFF 300, 600, 900 seconds or none
- n) number of Z or RCD measurements (for rechargeable batteries) >5000 (2 measurements / minute)
- o) display LCD segment
- p) measurement results memory 990 cells, 10 000 entries
- q) transmission of results Bluetooth
- r) quality standard development, design and manufacture acc. to ISO 9001, ISO 14001, PN-N-18001
- s) instrument conforming to IEC 61557
- t) product meets the EMC requirements (resistance for industrial environments) according to the standards EN 61326-1 and EN 61326-2-2

NOTE

* Information about the use of meter at altitude from 2000 m to 5000 m

As for voltage inputs E, S, H the instrument is to be considered downgraded to measurement category CAT III 150 V to ground (max 150 V between inputs) or CAT IV 100 V to ground (max 100 V between inputs). Markings and symbols indicated on the instrument are to be considered valid when using it at altitude lower than 2000 m.

10.3 Additional information

Information about additional uncertainty is useful mainly when the meter is used in untypical conditions and for the measurements laboratories during calibration.

10.3.1 Additional uncertainty according to IEC 61557-3 (Z)

Influencing value	Designation	Additional uncertainty
Location	E ₁	0%
Supply voltage	E ₂	0% (BAT is not displayed)
Temperature 0...35°C	E ₃	1.2 m lead – 0 Ω 5 m lead – 0.011 Ω 10 m lead – 0.019 Ω 20 m lead – 0.035 Ω WS-01, WS-03, WS-04, WS-05 leads – 0.015 Ω
Phase angle 0...30° at the bottom of measurement range	E _{6.2}	0.6%
Frequency 99%...101%	E ₇	0%
Mains voltage 85%...110%	E ₈	0%
Harmonics	E ₉	0%
DC component	E ₁₀	0%

10.3.2 Additional uncertainty according to IEC 61557-4 (R ±200 mA)

Influencing value	Designation	Additional uncertainty
Location	E ₁	0%
Supply voltage	E ₂	0,5% (BAT is not displayed)
Temperature 0...35°C	E ₃	1,5%

10.3.3 Additional uncertainty according to IEC 61557-6 (RCD)

I_A, t_A, U_B

Influencing value	Designation	Additional uncertainty
Location	E ₁	0%
Supply voltage	E ₂	0% (BAT is not displayed)
Temperature 0...35°C	E ₃	0%
Electrodes resistance	E ₅	0%
Mains voltage 85%...110%	E ₈	0%

10.3.4 Influence of serial interference voltage on the resistance measurements for function R_E3P

R _E	U _N	Additional uncertainty [Ω]
0,00...10,00 Ω	25 V	±(0.001 R _E +0.01) U _Z +0.007 U _Z ²
	50 V	±(0.001 R _E +0.01) U _Z +0.004 U _Z ²
10.01...1999 Ω	25 V, 50 V	±(0.001 R _E +0.01) U _Z +0.001 U _Z ²

10.3.5 **MPI-507** Influence of the auxiliary electrodes on earth resistance measurements for function R_E3P

R _H , R _S	Additional uncertainty [%]
R _H ≤ 1.99 kΩ R _S ≤ 1.99 kΩ	$\pm \left(\frac{R_S}{R_S + 100000} \cdot 150 + \frac{R_H \cdot 0,004}{R_E} + 1,5 \cdot 10^{-8} \cdot R_H^2 \right)$

R_E[Ω], R_S[Ω] and R_H[Ω] are values displayed by the device.

10.3.6 **MPI-507** Additional uncertainties according to IEC 61557-5 (R_E3P)

Significant parameter	Designation	Additional uncertainty
Position	E ₁	0%
Supply voltage	E ₂	0% (BAT is not lit)
Temperature	E ₃	±0,2 digit/°C for R < 1 kΩ ±0,07%/°C ± 0,2 digit/°C for R ≥ 1 kΩ
Serial interference voltage	E ₄	According to the formulas shown in sec. 10.3.4 (U _N =3 V 50/60 Hz)
Resistance of auxiliary electrodes	E ₅	According to the formula in sec. 10.3.5

11 Accessories

The current list of accessories can be found on the manufacturer's website.

11.1 Standard accessories

The standard kit delivered by the manufacturer includes:

Name	MPI-502F	MPI-506	MPI-507
• MPI-502F / 506 / 507 meter	√	√	√
• WS-03 adapter with START button with UNI-SCHUKO plug – WAADAWS03	√	√	√
• 1.2 m test lead (CAT III 1000 V) with banana plugs, yellow – WAPRZ1X2YEBB	√	√	√
• 1.2 m test lead (CAT III 1000 V) with banana plugs, red – WAPRZ1X2REBB	√	√	√
• 1.2 m test lead (CAT III 1000 V) with banana plugs, blue – WAPRZ1X2BUBB	√	√	√
• crocodile clip (CAT III 1000 V) yellow – WAKROYE20K02	√	√	√
• crocodile clip (CAT III 1000 V) red – WAKRORE20K02		√	√
• pin probe with banana socket (CAT III 1000 V) yellow – WASONYEOGB1		√	√
• pin probe with banana socket (CAT III 1000 V) red – WASONREOGB1	√	√	√
• pin probe with banana socket (CAT III 1000 V) blue – WASONBUOGB1	√	√	√
• 30 m test lead at a winder, red – WAPRZ030REBBN			√
• 15 m test lead at a winder, blue – WAPRZ015BUBBN			√
• 2x earth contact probe (rod), 25 cm – WASONG25			√
• case for meter and accessories – WAFUTM6	√	√	√
• meter harness – WAPOZSZE4	√	√	√
• rigid hanger with hook – WAPOZUCH1	√	√	√
• user manual	√	√	√
• factory calibration certificate	√	√	√
• 4x 1.5 V AA battery	√	√	√

11.2 Optional accessories

In addition, the following items not included in the standard kit can be purchased from the manufacturer or the distributors:

- General measurements

WS-04 adapter with UNI-SCHUKO angular plug (without triggering)

WAADAWS04



Crocodile clip blue 1 kV 20 A
WAKROBU20K02



Foldable pin probe, 1 kV, 2 m (banana socket)

WASONSP2M



- Test lead red 1 kV (banana plugs)

5 / 10 / 20 m long

WAPRZ005REBB

WAPRZ010REBB

WAPRZ020REBB



- Three-phase socket adapter 16 A

5-lead version
AGT-16P

WAADAAGT16P



4-lead version
AGT-16C

WAADAAGT16C



- Three-phase adapter 32 A socket

5-lead version
AGT-32P
WAADAAGT32P



4-lead version
AGT-32C
WAADAAGT32C



- Three-phase adapter 63 A socket

5-lead version
AGT-63P
WAADAAGT63P



- Industrial phase adapter socket

AGT-16T 16 A
WAADAAGT16T



AGT-32T 32 A
WAADAAGT32T



- TWR-1J - RCD breaker testing adapter

WAADATWR1J



- Calibration certificate with accreditation

12 Manufacturer

The manufacturer of the equipment and provider of service during and past the warranty period:

SONEL S.A.

Wokulskiego 11
58-100 Świdnica
Poland

tel. +48 74 858 38 60

fax +48 74 858 38 09

E-mail: export@sonel.pl

Web page: www.sonel.pl



NOTE!

Service repairs must be performed solely by the manufacturer.

13 Laboratory services

SONEL Testing and Calibration Laboratory has been accredited by the Polish Center for Accreditation (PCA) - certificate no. AP 173.

Laboratory offers calibration for the following instruments that are used for measuring electrical and non-electrical parameters.



AP 173

● METERS FOR MEASUREMENTS OF ELECTRICAL PARAMETERS

- voltage meters,
- current meters (including clamp meters),
- resistance meters,
- insulation resistance meters,
- earth resistance and resistivity meters,
- RCD meters,
- short-circuit loop impedance meters,
- power quality analyzers,
- portable appliance testers (PAT),
- power meters,
- multimeters,
- multifunction meters covering the functions of the above-mentioned instruments,

● ELECTRICAL STANDARDS

- calibrators,
- resistance standards,

● METERS FOR MEASUREMENTS OF NON-ELECTRICAL PARAMETERS

- pyrometers,
- thermal imagers,
- luxmeters.

The Calibration Certificate is a document that presents a relation between the calibration standard of known accuracy and meter indications with associated measurement uncertainties. The calibration standards are normally traceable to the national standard held by the National Metrological Institute.

According to ILAC-G24 „Guidelines for determination of calibration intervals of measuring instruments”, SONEL S.A. recommends periodical metrological inspection of the instruments it manufactures no less frequently than once every 12 months.

For new instruments provided with the Calibration Certificate or Validation Certificate at the factory, re-calibration should be performed within 12 months from the date of purchase, however, no later than 24 months from the date of purchase.



ATTENTION !

The person performing the measurements should be absolutely sure about the efficiency of the device being used. Measurements made with an inefficient meter can contribute to an incorrect assessment of the effectiveness of health protection and even human life.

NOTES

MEASUREMENT MESSAGES



NOTE!

The meter is designed for operation at rated phase voltages of 220 V, 230 V and 240 V and phase-to-phase voltages of 380 V, 400 V, 415 V.

Connecting voltage higher than allowed between any of the test terminals may damage the meter and cause a hazard to the user.

Measurements

NOISE!

Interference voltage occurs on the tested object. Measurement is possible but may be burdened with additional uncertainty.

READY

The meter is ready for measurement.



Maximum temperature of the meter is exceeded. The measurement is blocked.



Phase connected to N terminal instead of L terminal (for example, exchange of L and N in the mains socket).

---E no

An incompatible measurement adapter is connected to the meter.

E00

Short-circuit loop of the meter is faulty.

Err

Error during measurement.

ErrU

Error during the measurement: loss of voltage after the measurement.

L-n

Voltage on terminals L and N is not within measurable range.

L-PE

Voltage on terminals L and PE is not within measurable range.

Ub

Safe contact voltage exceeded.

Udet

The tested facility is live. The measurement is blocked. **Immediately disconnect the meter from the object (both test leads).**

ULn

Error in connection of N conductor.

RCD measurements

FAIL

RCD not in good working order.

PASS

RCD in good working order.

rcd

RCD did not trip or tripped too late.

turn rcd
on

Switch on the RCD.

R_E measurements

rH

Interruption in the current probe circuit.

rS

Interruption in the voltage probe circuit.

rHS

Interruption in measuring circuit or resistance of test probes is higher than 2 kΩ.

Battery / rechargeable battery status



Charged.



Discharged.

bAt

Completely discharged. Replace or recharge the batteries.



SONEL S.A.
Wokulskiego 11
58-100 Świdnica
Poland



+48 74 858 38 60
+48 74 858 38 00
fax +48 74 858 38 09

e-mail: export@sonel.pl
www.sonel.pl